

CD RECEIVER

KDC-W4031/Y
KDC-W409/Y
KDC-W431GY
KDC-W4531/Y
KDC-WF431A

SERVICE MANUAL

KENWOOD

© 2004-12 PRINTED IN JAPAN
B53-0230-00 (N) 1813

PANEL ASSY
KDC-W4031/Y (A64-3455-02)

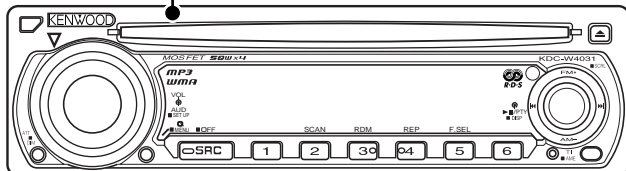

PANEL ASSY
KDC-W409/Y (A64-3456-02)

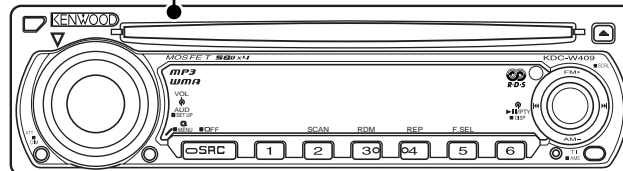

PANEL ASSY
KDC-W431GY (A64-3457-02)

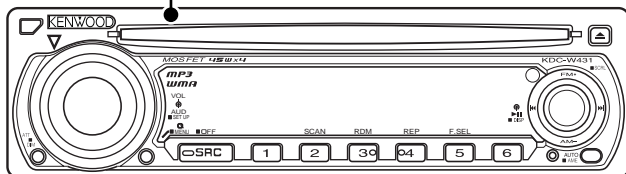

PANEL ASSY
KDC-W4531/Y (A64-3454-02)

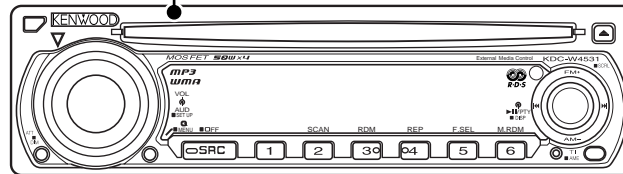

PANEL ASSY
KDC-WF431A (A64-3466-02)

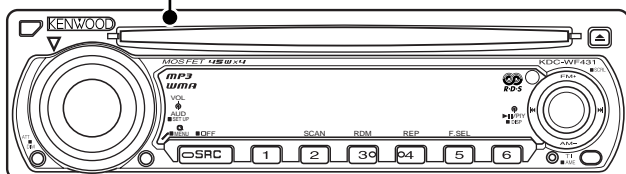

SPARE TDF PANEL

MAIN UNIT NAME	TDF PARTS No.	TDF NAME
KDC-W4031/Y	Y33-2140-60	TDF-W4531
KDC-W409/Y	Y33-2140-65	TDF-W409
KDC-W431GY	Y33-2140-61	TDF-W431GY
KDC-W4531/Y	Y33-2140-60	TDF-W4531
KDC-WF431A	Y33-2140-63	TDF-WF431

LEVER
(D10-4589-04) x2

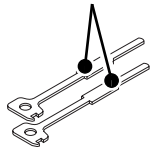

DC CORD
(E30-6413-05)

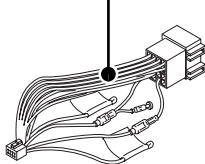

PLASTIC CABINET ASSY
(A02-2736-03)

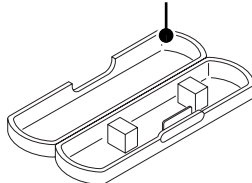

MOUNTING HARDWARE ASSY
(J21-9716-03)

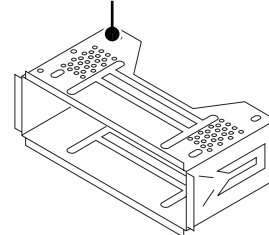

ANTENNA ADAPTOR
(T90-0523-05)



* ESCUTCHEON
(B07-xxxx-xx)

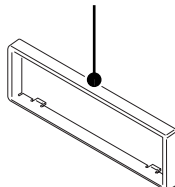

* Depends on the model. Refer to the parts list.

BLOCK DIAGRAM

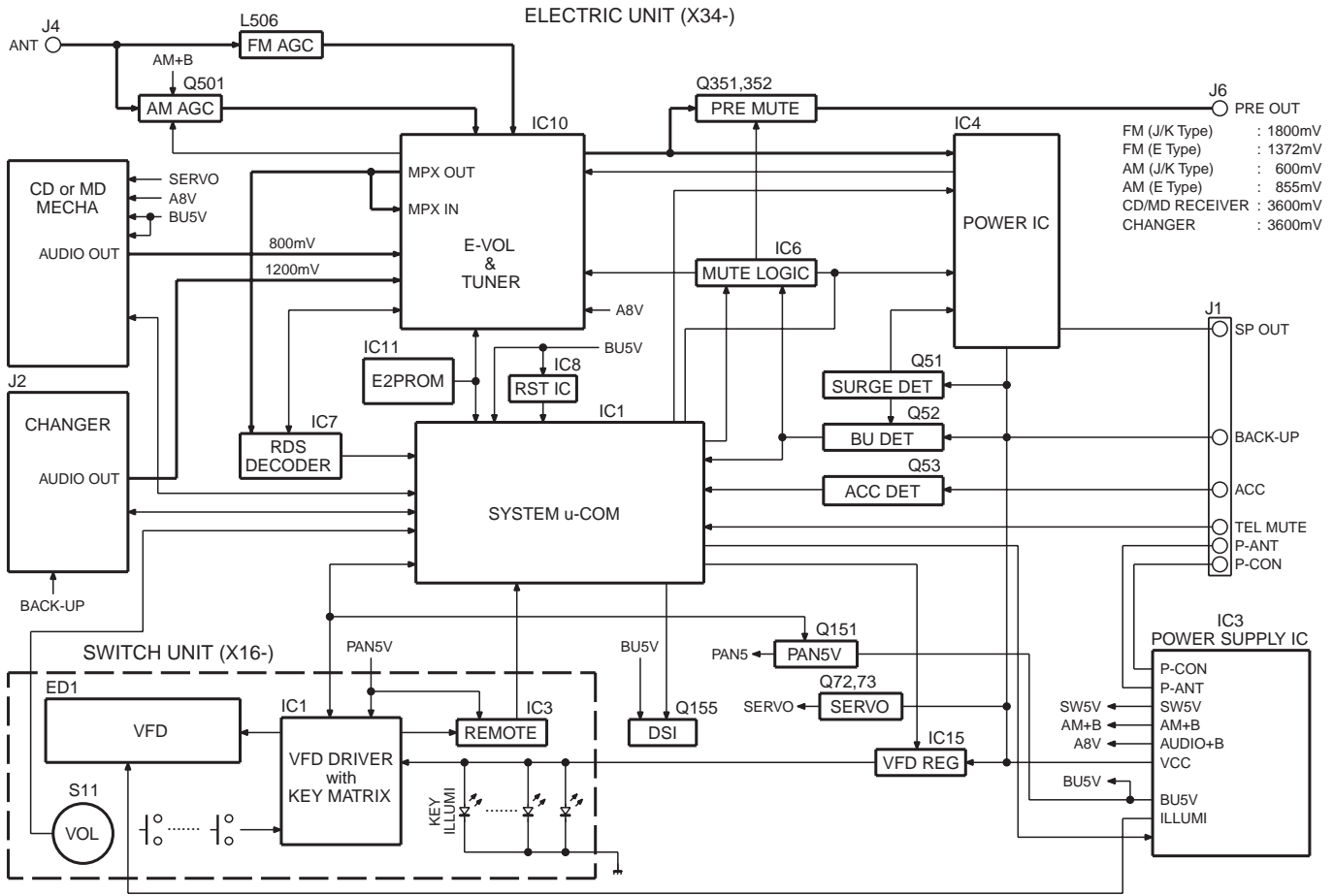

CD PLAYER UNIT (X32-5500-00)

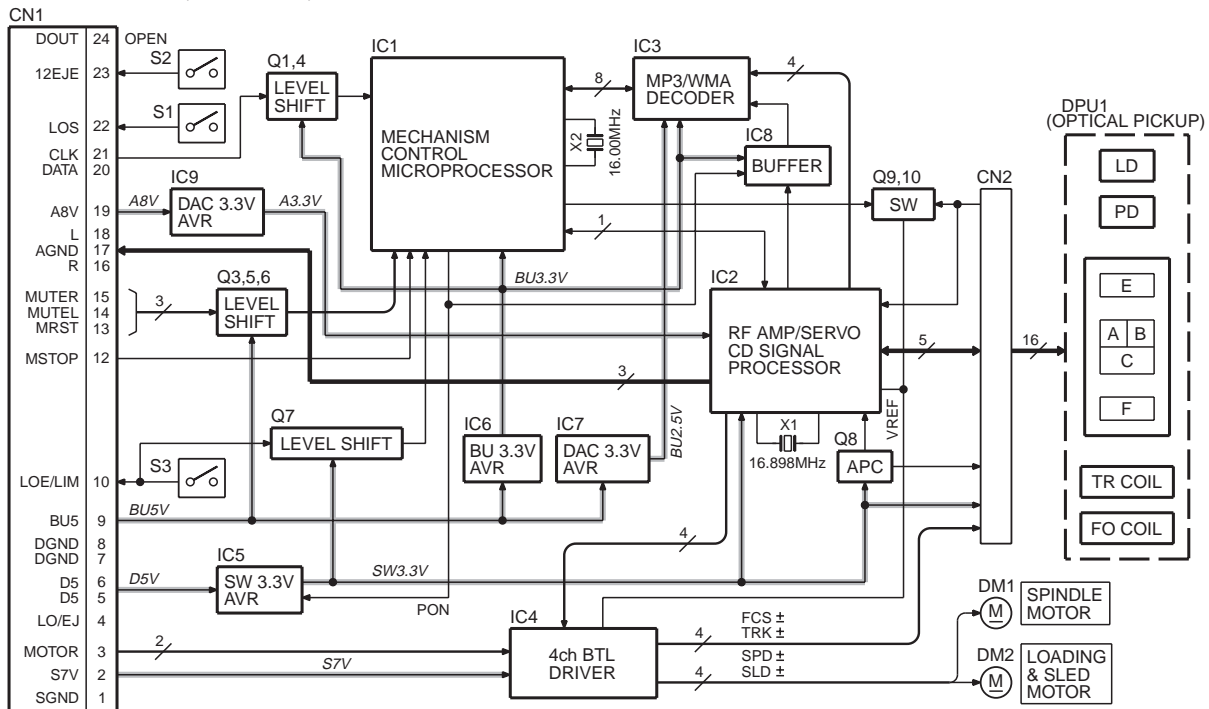

COMPONENTS DESCRIPTION

● ELECTRIC UNIT (X34-3402-7x)

Ref. No.	Application / Function	Operation / Condition
IC1	SYSTEM μ -COM	System control.
IC3	POWER SUPPLY	DC5Vx2, 7.9Vx1, 8.1Vx1, 10.3V, P.CON, P-ANT output.
IC4	POWER IC	Audio signal amplifier.
IC6	MUTE LOGIC	Mute control.
IC7	RDS DECODER	RDS decode.
IC8	RESET	"L" when detection voltage goes below 3.6V.
IC10	E-VOL & TUNER	E-VOL, Tuner, Stereo decode.
IC11	E2PROM	Saves and writes tuner adjustment data.
IC15	VFD REGULATOR	11.3V output voltage for LED and VFD.
Q51	SERGE DET	"ON" when the base goes "H".
Q52	BU DET	"ON" when the base goes "H".
Q53	ACC DET	"ON" when the base goes "H".
Q71	SERVO+B CONTROL SW	"ON" when the base goes "H".
Q72,73	SERVO+B AVR	Output voltage level : 7.5V.
Q74	IC3 CONTROL SW	"ON" when the base goes "H" (Output voltage : 10.3V).
Q151	PANEL 5V SW	"ON" when the base goes "L".
Q155	DSI ILLUMI SW	"ON" when the base goes "L".
Q252	IC4 STBY SW	"ON" when the base goes "L".
Q330	Q351, 352 MUTE DRIVER	"ON" when the base goes "L".
Q351	Lch PRE MUTE SW	Pre-output is muted when the base goes "H".
Q352	Rch PRE MUTE SW	Pre-output is muted when the base goes "H".
Q501	AM RF AMP	Adjusts for AM-RF gain.

● CD PLAYER UNIT (X32-5500-00)

Ref. No.	Application / Function	Operation / Condition
IC1	MECHANISM CONTROL MICROPROCESSOR	Focusing, tracking, sled and spindle servo processing. Automatic adjustment (Focusing, tracking, gain, offset and balance) operations. Digital signal processing (DSP, PLL, sub-codes, CIRC error correction, audio data interpolation) operations, and microcomputer function.
IC2	RF AMP/SERVO CD SIGNAL PROCESSOR	Generation of RF signal based on the signals from the APC circuit and pickup, and generation of servo error (Focusing error and tracking error) signals. Detection of dropout, anti-shock, track crossing and off-track conditions, included gain control function during CD-RW.
IC3	MP3/WMA DECODER	
IC4	4ch BTL DRIVER	Focusing coil, tracking coil, spindle motor and sled motor driver, disc loading and eject operation.
IC5	SW 3.3V AVR	
IC6	BU 3.3V AVR	3.3V power supply for back-up.
IC7	BU 2.5V AVR	2.5V power supply for back-up.

COMPONENTS DESCRIPTION

Ref. No.	Application / Function	Operation / Condition
IC8	SELECTOR (SERIAL DATA)	Serial audio data switch.
IC9	DAC 3.3V AVR	3.3V power supply for IC2.
Q1	LEVEL SHIFT	3.3V to 5.0V.
Q3~7	LEVEL SHIFT	3.3V to 5.0V.
Q8	AUTOMATIC POWER CONTROL	LD driver.
Q9,10	SWITCH	Switch for anticipation sub-beam delay.

● SWITCH UNIT (X16-2932-7x)

Ref. No.	Application / Function	Operation / Condition
IC1	VFD DRIVER	
IC3	REMOTE SENSOR	
Q1	GREEN LED SW	"ON" when the base goes "H".
Q2	RED LED SW	"ON" when the base goes "H".
Q21	PAN SW5V	"ON" when the base goes "H".

MICROCOMPUTER'S TERMINAL DESCRIPTION

● SYSTEM μ -COM : IC1 on X34- (ELECTRIC UNIT)

Pin No.	Active (H/L)	Pin Name	I/O	Application	Processing Operation
1		DC ERR	I	DC offset detection input	
2		LINE MUTE	I	Phone detection	NAVI MUTE : Over 2.5V, TEL MUTE : Below 1V
3		ROTARY CW	I	Rotary encoder input	
4		AVSS	-		
5		TUN TYPE1	I	E-VOL setting switch	Refer to "TUN TYPE" on the TRUTH TABLE
6		TUN TYPE2	I	E-VOL setting switch	Refer to "TUN TYPE" on the TRUTH TABLE
7		AVREF1	-		
8		VFD DATAF	I	Data input from VFD driver	
9		VFD DATAS	O	Data output to VFD driver	
10		VFD CLK	O	Clock output to VFD driver	

MICROCOMPUTER'S TERMINAL DESCRIPTION

Pin No.	Active (H/L)	Pin Name	I/O	Application	Processing Operation
11	L	VFD RST	O	Reset output to VFD driver	Display OFF, Key reset, TDF panel OFF : L Display ON, Key scan : H
12		VFD CE	O	Chip enable output to VFD driver	
13		ROTARY CCW	I	Rotary encoder input	
14	L	TDF DET	I	TDF panel detection	TDF panel OFF : H, TDF panel ON : L
15		PWIC BEEP	O	Beep output	
16		LX DATA S	I	Data from slave unit	
17		LX DATA M	O	Data to slave unit	
18		LX CLK	I/O	LX-BUS clock	
19		RDS AFSL	O	Tuner RDS mute output	Refer to "RDS AFSL" on the TRUTH TABLE
20	L	TUN ADJ	I	For adjusting IC10	Adjustment=H, PS1-1,2=L, PS1-3=Hi-Z, PS2-1,2=Hi-Z, TUN DATA, CLK=Hi-Z
21		TUN SD	I	Tuner search stop output	H : Station exists, L : Station does not exist
22	H	LX RST	O	Hard reset to slave unit	H : Reset, L : Normal condition
23	H	LX CON	O	Start-up request to slave unit	H : Slave unit ON, L : Slave unit OFF
24		LX REQ M	O	Communication request to slave unit	
25		AUD SDA	I/O	Volume + tuner I2C data input and output	
26		AUD SCL	I/O	Volume + tuner I2C clock input and output	
27	H	PWIC STBY	O	Power IC standby output	Power IC ON : H, Power IC OFF : L
28	H	VOL MUTE	O	E-VOL mute output	L : Mute OFF, Hi-Z : Mute ON
29	L	PWIC MUTE	O	Power IC mute output	Power OFF : L, Standby : L, Tel mute : L
30		TUN FANC OUT	O	Tuner block (inside the μ -com) check	OK : L, NG : H
31		RESET2	O	Mute for reset	Output L
32		RDS DATA	I	RDS decoder data input	
33		VSS1	-		
34		RDS QUAL	I	RDS decoder QUAL input	
35	L	ACC DET	I	ACC detection	ACC exists : L, ACC does not exist : H
36	L	BU DET	I	Momentary power-down detection	BU exists : L BU does not exist (Momentary power-down) : H
37		NC	-		
38		PS2-2	O	Power supply control output	Refer to "POWER IC CONTROL" on the TRUTH TABLE
39		PS2-1	O	Power supply control output	Refer to "POWER IC CONTROL" on the TRUTH TABLE
40		PS1-1	O	Power supply control output	Refer to "POWER IC CONTROL" on the TRUTH TABLE
41		PS1-2	O	Power supply control output	Refer to "POWER IC CONTROL" on the TRUTH TABLE
42		PS1-3	O	Power supply control output	Refer to "POWER IC CONTROL" on the TRUTH TABLE
43,44		NC	-		
45		CD MUTE	I	CD mute request	L : Mute request
46	L	CD MSTOP	O	CD mecha μ -com stop	H : mecha μ -com operates, L : mecha μ -com is stopped
47		CD LOE LIM SW	I	CD detection (chucking switch)	H : Loading is finished, L : Disc does not exist

MICROCOMPUTER'S TERMINAL DESCRIPTION

Pin No.	Active (H/L)	Pin Name	I/O	Application	Processing Operation
48		CD LOEJ	I/O	CD motor control	Refer to "CD MECHA CONTROL OPERATION" on the TRUTH TABLE
49		CD MOTOR	O	CD motor control	Refer to "CD MECHA CONTROL OPERATION" on the TRUTH TABLE
50		NC	-		
51	L	CD MRST	O	CD mecha μ -com reset	H : Normal condition, L : Reset
52		CD SCL	I/O	CD mecha I2C clock output	
53		CD DISC12 SW	I	12cm CD detection	
54		CD LOS SW	I	CD loading detection	
55		CD SDA	I/O	CD mecha I2C data input and output	
56		OEM DISP CE	I/O	External display chip enable	External display
57		OEM DISP CLK	I/O	External display clock	External display
58		OEM DISP DATA	I/O	External display chip data	External display
59		DSI	O	DSI control	DSI ON : H, DSI OFF : L, TDF DET=H (DSI blinks)
60	L	RESET	I		
61		NC	-		
62	L	PON FL	O	VFD power supply ON	VFD ON : H, VFD OFF : L TDF DET H (DSI blinks) : L, TDF DET L : H
63		KEY REQ	I	Communication request from VFD driver	L : Key input
64		RDS CLK	I	RDS decoder clock input	
65		REMOTE	I	Remote control input	
66		LX REQ S	I	Communication request from slave unit	
67		VSS0	-		
68		VDD1	-		
69		X2	-		
70		X1	-		
71		TEST	-		
72		XT2	-		
73		XT1	-		
74		VDD0	-		
75		AVDD	-		
76~78		TYPE 3~TYPE 1	I	Destination switch	
79		RDS NOISE	I	Tuner quality (Noise) input	
80		TUN SMETER	I	Tuner S-meter input	

MICROCOMPUTER'S TERMINAL DESCRIPTION

● TRUTH TABLE

• TUN TYPE

	TYPE 1	TYPE 2
General models commercially-designated as pure KENWOOD brand (Initial value) Initial value setting	L	L

• RDS AFSL (AF search)

High	Normal condition communication (IC10 side : High) (Quality time constant long / Stereo Decoder PLL : Not hold)
Low	AF search (IC10 side : Middle) (Quality time constant short / Stereo Decoder PLL : Hold)

• POWER SUPPLY IC (IC3) CONTROL

SEL1 (Pin No. 11)

PS1-2	PS1-3	PS2-1	ILLUMI	P-CON	P-ANT
L	L	L	OFF	OFF	OFF
L	L	H	ON	OFF	OFF
H	L	H	ON	ON	OFF
H	H	H	ON	ON	ON

SEL2 (Pin No. 12)

PS1-1	PS2-2	AUDIO	SW5	AM
L	L	OFF	OFF	OFF
H	L	ON	ON	OFF
H	H	ON	ON	ON

• CD MECHA CONTROL OPERATION

CD LOEJ	CD MOTOR	CD MECHA OPERATION
L	H	Load
H	H	Eject
Hi-Z	L	Stop
Hi-Z	H	Brake

MICROCOMPUTER'S TERMINAL DESCRIPTION

● CD MECHANISM μ -COM : IC1 on X32- (CD PLAYER UNIT)

Pin No.	Active (H/L)	Pin Name	I/O	Application	Processing Operation
1		VREFL	-	Reference power supply input terminal for ADC (L).	GND
2		AVSS	-	GND terminal for ADC.	GND
3		AVCC	-	Power supply terminal for ADC.	Back-up 3.3V
4		NC	-		
5	L	20RST	O	Reset control (Decoder).	L : Reset, H : Normal condition
6		20ACK	I	Acknowledge signal input (Decoder).	
7		20STBY	O	Standby control (Decoder).	H : Standby, L : Normal condition
8,9		NC	-		
10		20INT	I	Interrupt signal input (Decoder).	
11		FOGUP	I	Focus gain-up interrupt.	H : Focus gain-up, L : Normal condition
12		LZM	I	0 bit mute detection (Lch).	L : MUTE OFF, H : MUTE ON
13		RZM	I	0 bit mute detection (Rch).	L : MUTE OFF, H : MUTE ON
14,15		NC	-		
16	L	20CS	O	Chip select signal output (Decoder).	
17	L	20LP	O	Latch pulse signal output (Decoder).	
18		20TXD0	I/O	Data output for serial data (Decoder).	Input condition is kept except in output condition.
19		20RXD0	I	Data input for serial data (Decoder).	
20		20SCLK0	O	Clock output for serial data (Decoder).	
21		DSPTXD1	O	Data output for serial data (DSP).	
22		DSPRXD1	I	Data input for serial data (DSP).	
23		DSPSCLK1	O	Clock output for serial data (DSP).	
24		AM0	-	ROM mode selection terminal.	H : Normal condition, L : External ROM mode
25		DVCC	-	Back-up 3.3V.	
26		X2	O	Resonator terminal.	16MHz
27		DVSS	-	GND.	
28		X1	I	Resonator terminal.	16MHz
29		AM1	I	"H" condition is fixed.	Back-up 3.3V
30	L	RESET	I	Reset detection.	L : Reset, H : Normal condition
31~34		NC	-		
35	L	DSPSTB	O	Data strobe signal output (DSP).	
36		DSPA0	O	Command/Parameter identification signal output (DSP).	H : Parameter data output, L : Command data output
37	L	DSPRST	O	Reset control (DSP).	
38		DSPINT	I	Interrupt signal input (DSP).	H : Interrupt
39		NC	-		
40		SEARCH	O	Search condition output.	H : Search, L : Normal condition
41		LOE/LIM SW	I	Loading-end detection/Pick-up inner circumference detection	H : Inner circumference
42~49		NC	-		

MICROCOMPUTER'S TERMINAL DESCRIPTION

Pin No.	Active (H/L)	Pin Name	I/O	Application	Processing Operation
50		FLAGIN	I	C2Err impossibility detection.	L : Correction is possible. H : Correction is impossible.
51-61		NC	-		
62		DVSS	-	GND.	
63	L	NMI	I	Non-maskable interrupt request.	
64		DVCC	-	Power supply terminal.	
65-77		NC	-		
78		NC/BOOT	I	Mask : Not connected. Flash : For writing (Active "L").	L : Write, H : Normal condition
79,80		NC	-		
81		POND3.3	O	Digital 3.3V power-on control terminal.	H : POWER ON
82	L	MUTEL	O	Lch audio mute control.	
83	L	MUTER	O	Rch audio mute control.	
84		SDA	I/O	I2C data (Main μ -com).	
85		SCL	I/O	I2C clock (Main μ -com).	
86	L	MSTOP	I	Stand-by comeback interrupt.	L : Stop, H : Stop is released.
87		NC	-		
88	L	DMUTE	O	Driver mute.	L : MUTE ON, H : MUTE OFF
89		DVCC	-	Power supply terminal.	
90		NC	-		
91		DVSS	-	GND.	
92,93		NC	-	GND.	
94		MSEL	I	Memory capacity switching terminal.	H : Capacity size down, L : Capacity size up
95		NC	-	GND.	
96		ASEL	I	Audio output polarity switch.	H : Reverse output, L : Non-reverse output
97		CHSEL	I	Changer destination terminal.	H : Changer, L : Other source
98		SEL0	I	μ -com destination terminal 0.	
99		SEL1	I	μ -com destination terminal 1.	
100		VREFH	I	Reference power supply input terminal for ADC (H).	Back-up 3.3V

TEST MODE

How to enter the test mode

While simultaneously press PRESET "1" key and PRESET "3" key, press "RESET" button.

How to release the test mode

Press "RESET" button. (The release cannot be achieved in the conditions of POWER OFF and ACC OFF.)

Initial conditions of the test mode

- The source is "STANDBY".
- The displays all lit up.
- The volume is at -10dB (The display shows "30".)
- LOUD is "OFF".
- CRSC is "OFF".
- SYSTEM Q is "NATURAL".
- BEEP is sounded at all time with the key depressed for less than 1 second.

Special displays when all indicator lights are lighted

When "PRESET" keys are pressed while all indicators for the STANDBY sources are lighted, the following displays will appear.

PRESET "1" key	<ul style="list-style-type: none"> • Version display (8 digits : month, date, hour, minute) (Display) : x x x x x x x x
PRESET "2" key	<ul style="list-style-type: none"> • Serial number display (8 digits) (Display) : x x x x x x x x
PRESET "3" key	<ul style="list-style-type: none"> • When pressed for less than 1 second : POWER ON time display (STANDBY source time is not counted.) (Display) : PON x x x x x MAX 60,000 (hours) * The display is cleared by pressing the key for more than 2 seconds.
PRESET "4" key	<ul style="list-style-type: none"> • When pressed for less than 1 second : CD operation time display (Display) : PLY x x x x x MAX 60,000 (hours) * The display is cleared by pressing the key for more than 2 seconds.

PRESET "5" key	<ul style="list-style-type: none"> • When pressed for less than 1 second : CD EJECT number display (Display) : EJC x x x x x MAX 60,000 (times) * The display is cleared by pressing the key for more than 2 seconds.
PRESET "6" key	<ul style="list-style-type: none"> • When pressed for less than 1 second : Panel open/close number display (Display) : PNL x x x x x MAX 600,000 (times) * The display is cleared by pressing the key for more than 2 seconds.
"FM" key	<ul style="list-style-type: none"> • ROM CORRECTION version display (Display) Effective : ROM _ Rxxx (x : number) Not effective (When not able to read) : ROM _ R --- Not effective (When version is different) : ROM _ R***
"AM" key	<ul style="list-style-type: none"> • IC10 adjustment status (Refer to "ADJUSTMENT" on the following page.) (Display) Adjustment complete : E2P _ OK _ _ Adjustment not completed : E2P _ ER _ _ Communication error : I2C _ ER _ _ * When other than "E2P _ OK _ _", Pin No. 30 will become "H".
"◀◀" key	<ul style="list-style-type: none"> • Mechanism error detection status • Communication error → Error No. 1 → Error No. 2 → Error No. 3 → Communication error (Error No. 1 is the most recent error.) (Display) Communication OK : I2C _ OK _ _ Communication error : I2C _ NG _ _ Not detected : ERR _ n --- (n : 1~3) Detected : ERR _ n-** (** : error code) * The display is cleared by pressing the key for more than 2 seconds.

SPECIAL MODE

● Security (KDC-W4531/W4531Y only)

• How to enter the forced POWER ON mode

While “— — — —” is being displayed, while simultaneously pressing “Q” key and “4” key, press “RESET” button, With this, it is possible to turn the power on for 30 minutes only.

• How to register the security code on the “Car Audio Passport” sheet after replacing E2PROM (IC11)

1. Enter the test mode. (Refer to “How to enter the test mode”.)
 2. In the test mode, press “MENU” key to enter the MENU mode.
 When “SECURITY” is displayed, press “▶|” key (for less than 1 second) to enter the security registration mode.
 3. Input the security code, using “FM” / “AM” / “◀◀” / “▶▶” keys.
 “FM” key : number up / “AM” key : number down
 “▶▶” key : cursor to right / “◀◀” key : cursor to left
 4. After inputting the code, press “▶|” key for 3 seconds or more which causes “RE-ENTER” to be displayed. This is for “confirming” the code. Use the method in above No. “3” to re-enter the code.
 5. Then, press “▶|” key for 3 seconds or more, which will display “APPROVED”. This completes the security code registration.
 6. Release the test mode. (Refer to “How to release the test mode”.)
- * All clear cannot be used to clear the security code.

● DC offset error detection confirmation mode

Confirmation mode :

While depressing PRESET “3” key and PRESET “6” key simultaneously, press on the “RESET” button.

(Display) Detected : DC _ ERR _ _

Not detected : DC _ OK _ _ _

- * By pressing “TI” or “AUTO” key while “DC _ ERR _ _” is being displayed, detection status is cleared. This will result in the display of “DC _ OK _ _ _”.

Release Method : Press “RESET” button.

● Mechanism memory clear confirmation mode

Confirmation mode :

While depressing “ATT” key and “Q” key simultaneously, press “RESET” button.

(Display) : MEM _ CLR _

- * 2 seconds after the confirmation mode boots up, Mechanism memory clear as a result is displayed.

(Display) Clear status display normal completion

: CD _ O _ _ _

Clear status display abnormal completion

: CD _ X _ _ _

Release Method : Press “RESET” button.

ADJUSTMENT

After replacing the following parts, adjust as follows.

REPLACED PARTS		ADJUSTMENT ITEMS		
Ref. No.	Function / Parts name	1st AM MIX	2nd AM MIX	FM antenna
IC10	E-VOL & TUNER	YES	YES	YES
IC11	E2PROM	YES	YES	YES
L507	VCO COIL	YES	YES	YES
L508	1st AM MIX IFT	YES	-	-
L509	2nd AM MIX IFT	-	YES	-
L518	FM ANTENNA COIL	-	-	YES
D504	VARIABLE CAPACITANCE DIODE	YES	YES	YES
D506	VARIABLE CAPACITANCE DIODE	YES	YES	YES
X501	CRYSTAL RESONATOR	YES	YES	YES

● 1st AM MIX / 2nd AM MIX ADJUSTMENT

ADJUSTMENT POINT : L508 (1st AM MIX) / L509 (2nd AM MIX)

VOLTAGE VALUE CHECK POINT : S-METER check land (X34-)
 Adjust so that S-METER voltage value becomes maximum.

• SG setting

DESTINATION	FREQUENCY	MODULATION	ANTENNA INPUT
Europe	999kHz	OFF	35dB μ V (EMF)
Except Europe	1000kHz	OFF	35dB μ V (EMF)

● FM ANTENNA ADJUSTMENT

ADJUSTMENT POINT : L518

VOLTAGE VALUE CHECK POINT : S-METER check land (X34-)
 Adjust so that S-METER voltage value becomes maximum.

• SG setting

DESTINATION	FREQUENCY	MODULATION	ANTENNA INPUT
Europe	87.5MHz	OFF	5dB μ V (LOAD) or 11dB μ V (EMF)
Except Europe	87.9MHz	OFF	5dB μ V (LOAD) or 11dB μ V (EMF)

PC BOARD (COMPONENT SIDE VIEW)

(FOIL SIDE VIEW)

SWITCH UNIT X16-2932-7x (J76-0055-02)

SWITCH UNIT X16-2932-7x (J76-0055-02)

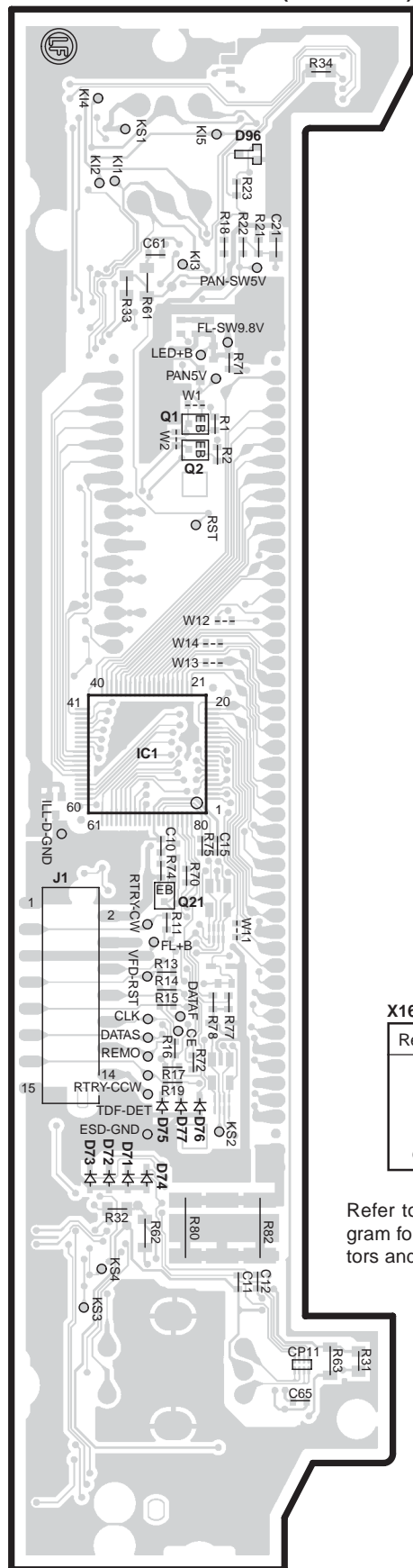
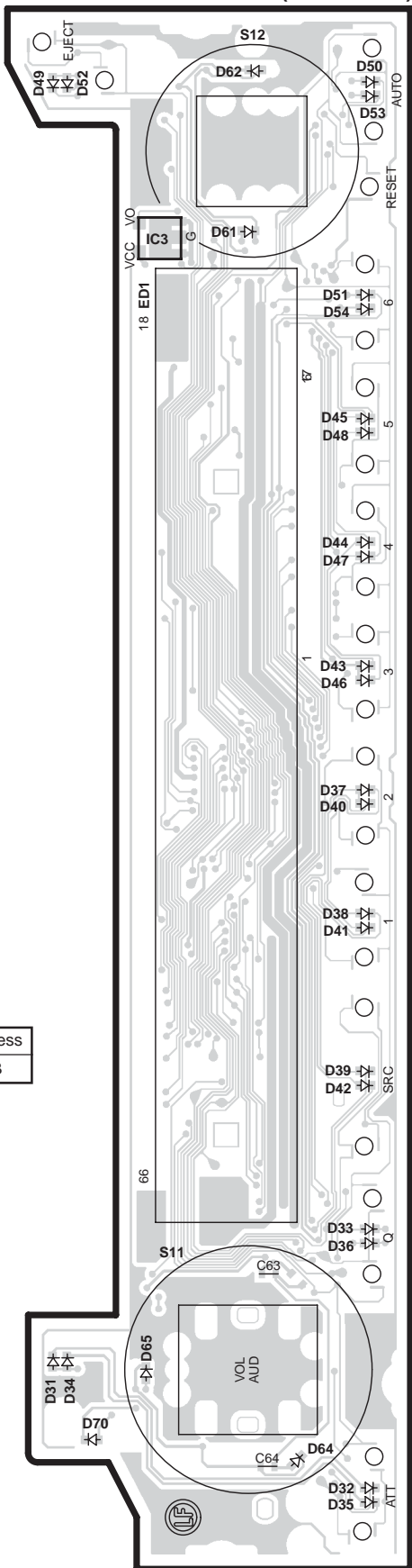

X16-2932-7x

Ref. No.	Address
IC3	2B

X16-2932-7x

Ref. No.	Address
IC1	4D
Q1	3D
Q2	3D
Q21	5D

Refer to the schematic diagram for the values of resistors and capacitors.

PC BOARD (FOIL SIDE VIEW)

ELECTRIC UNIT X34-3402-7x (J76-0048-12)

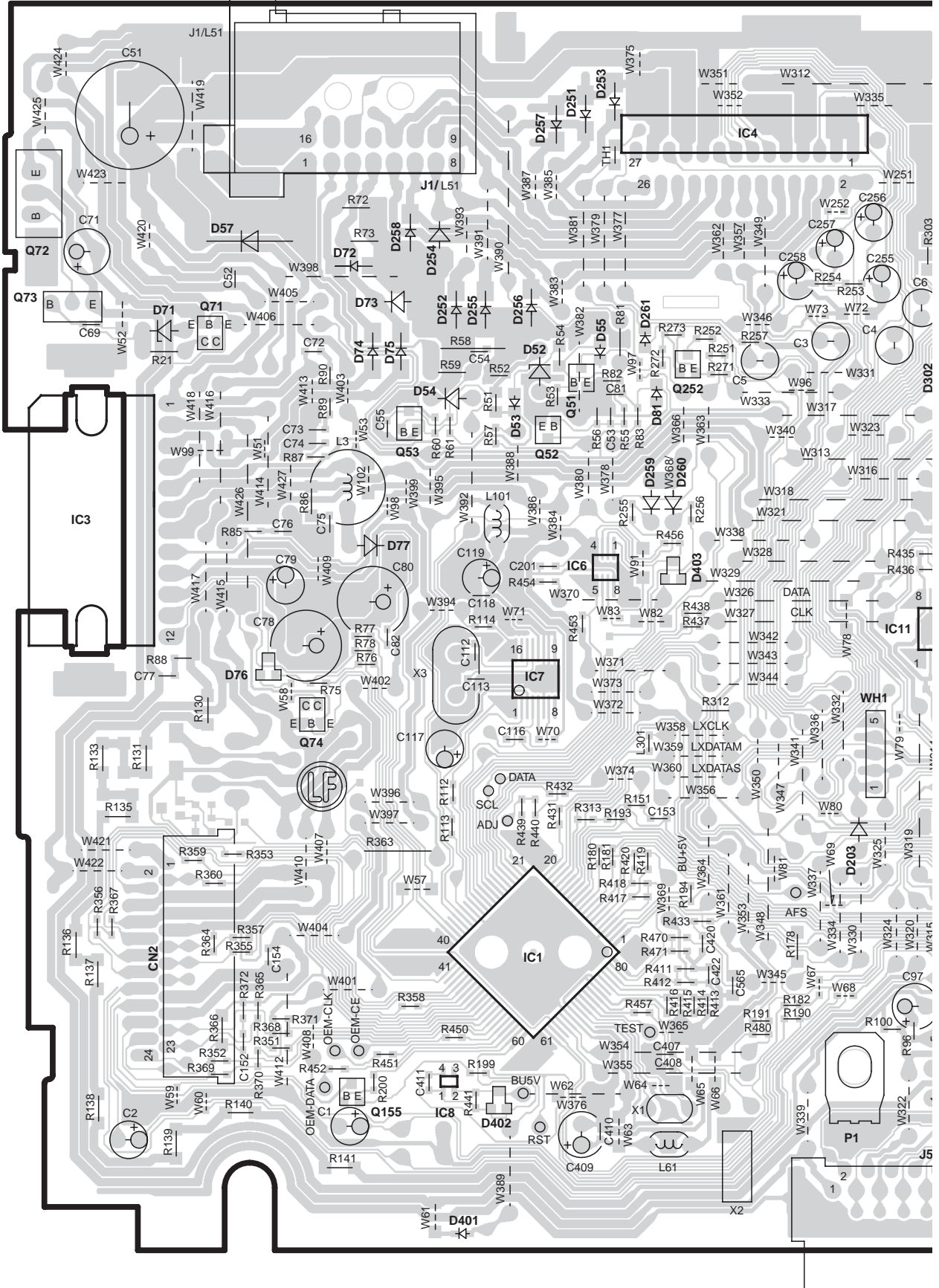

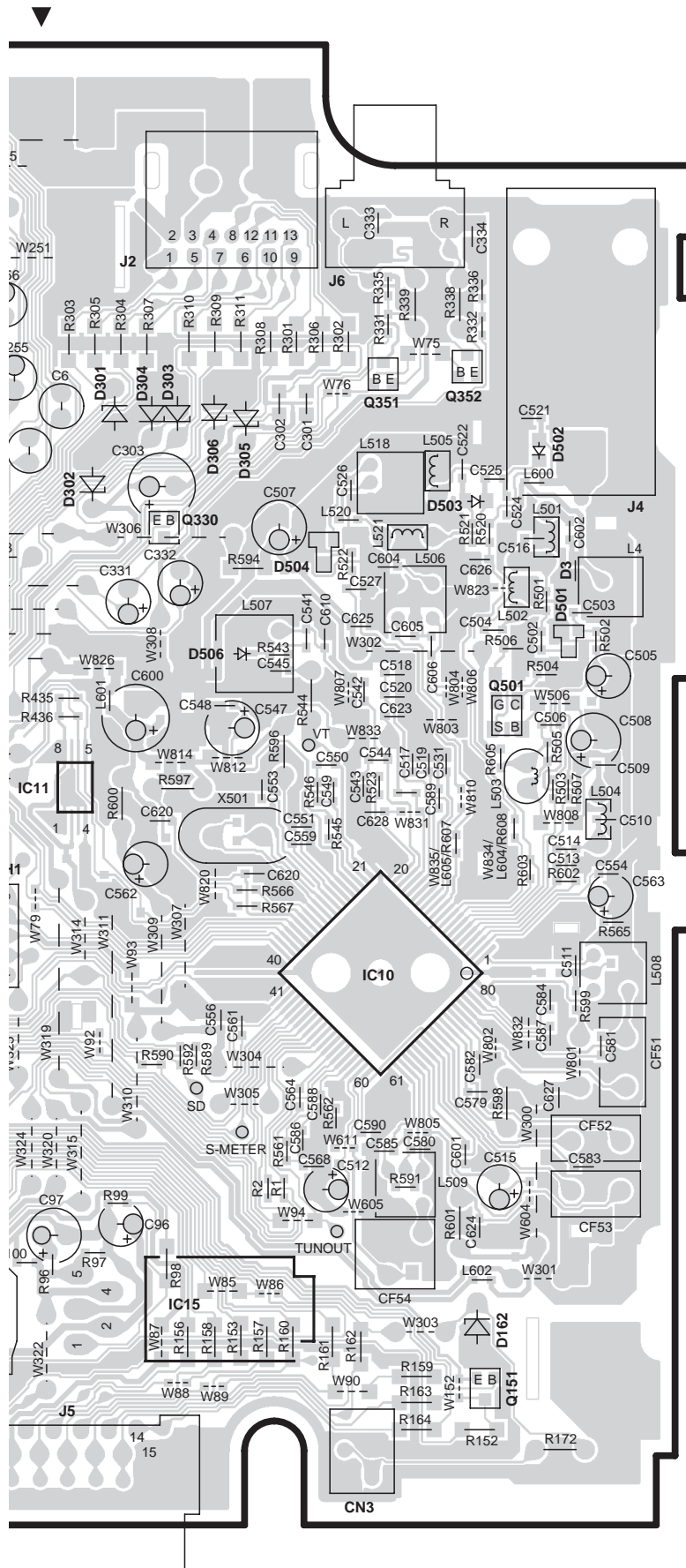

X34-3402-7x

Ref. No.	Address
IC1	6I
IC3	4G
IC4	2J
IC6	4I
IC7	4I
IC8	6H
IC10	5L
IC11	4K
IC15	6K
Q51	3I
Q52	3I
Q53	3H
Q71	3G
Q72	2F
Q73	3F
Q74	5H
Q151	6L
Q155	6H
Q252	3I
Q330	3K
Q351	3L
Q352	3L
Q501	4L

Refer to the schematic diagram for the values of resistors and capacitors.

PC BOARD (COMPONENT SIDE VIEW)

CD PLAYER UNIT X32-5500-00 (J74-1552-12)

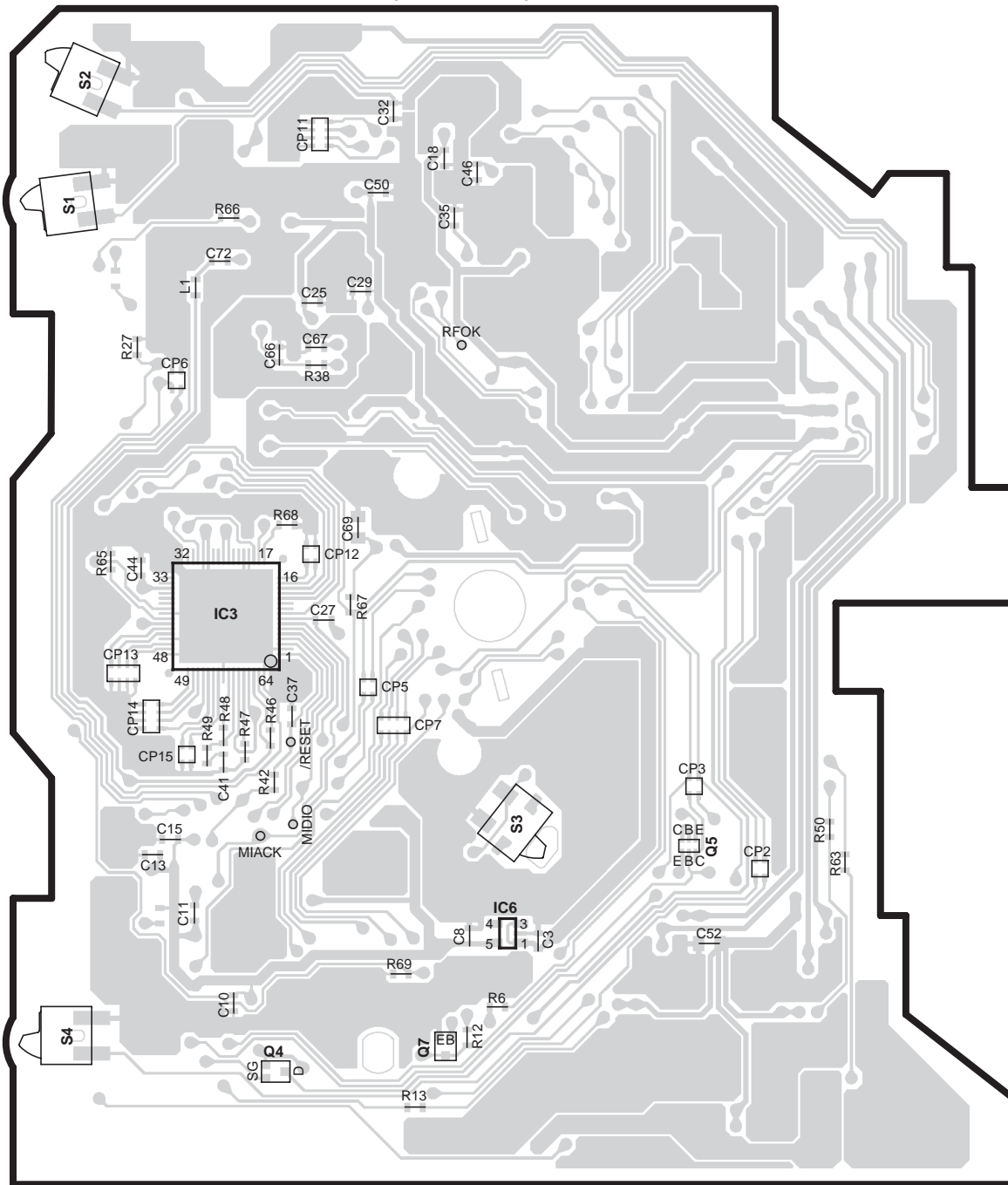

X32-5500-00

Ref. No.	Address
IC3	4Q
IC6	5R
Q4	5Q
Q5	5S
Q7	5R

Refer to the schematic diagram for the values of resistors and capacitors.

PC BOARD (FOIL SIDE VIEW)

CD PLAYER UNIT X32-5500-00 (J74-1552-12)

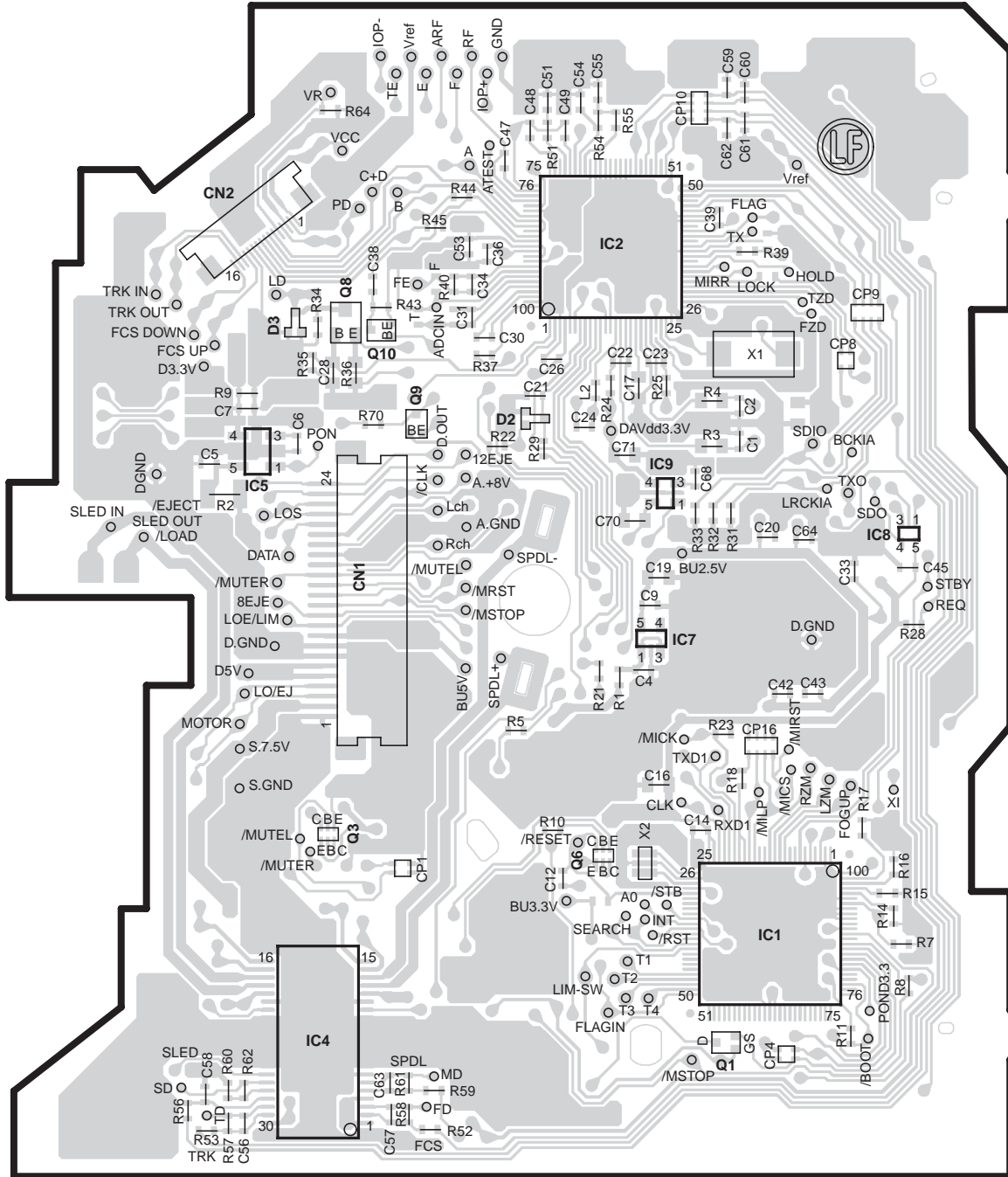

X32-5500-00

Ref. No.	Address	Ref. No.	Address
IC1	5X	Q1	5X
IC2	2W	Q3	5V
IC4	5V	Q6	5W
IC5	3V	Q8	2V
IC7	4W	Q9	3V
IC8	3X	Q10	3V
IC9	3W		

Refer to the schematic diagram for the values of resistors and capacitors.

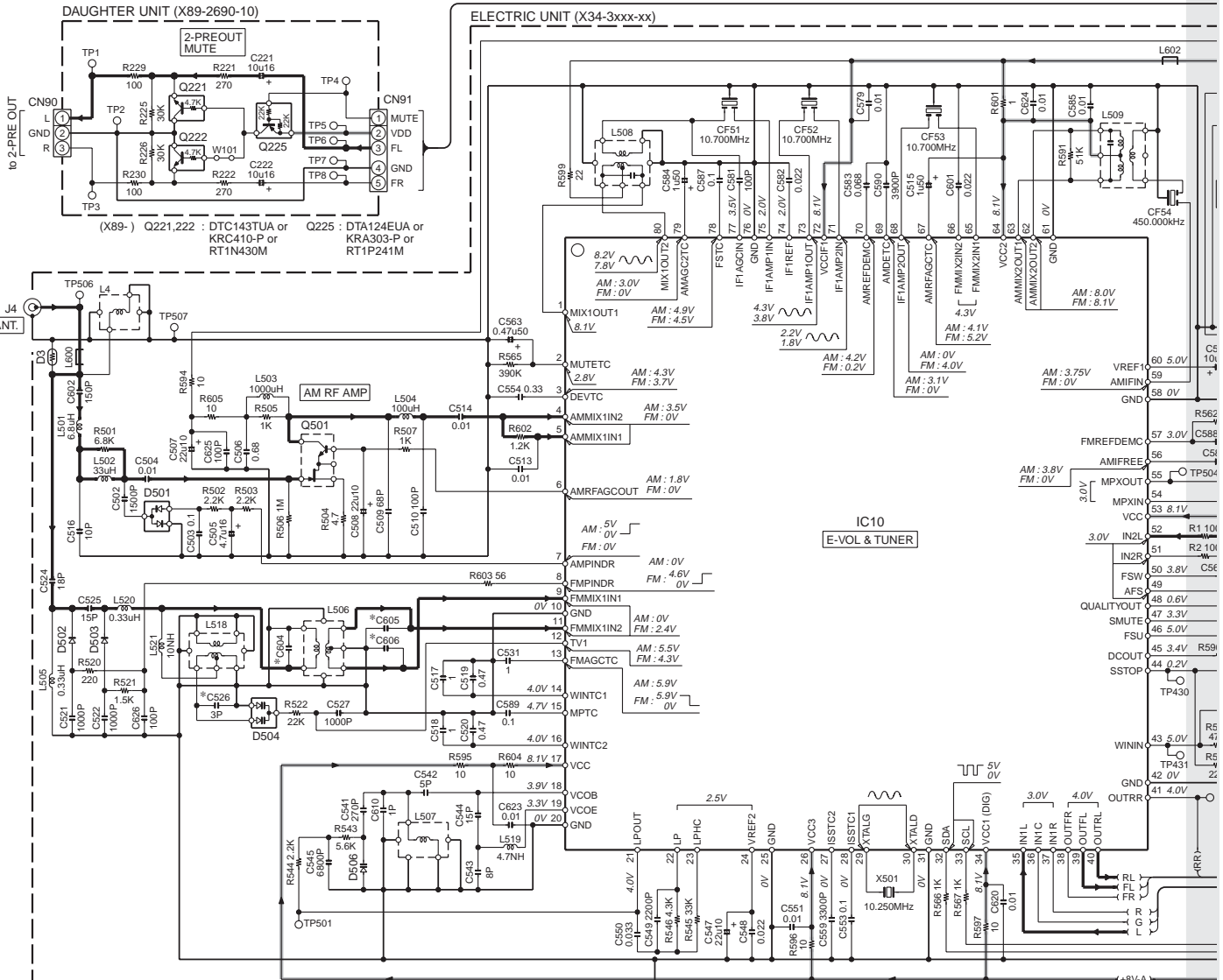

CATEGORY/ FUNCTION	MODEL NAME	DESTI- NATION	DAUGHTER UNIT X89-2690-10
CD RECEIVER (MP3/WMA)	E303/S	J	YES
	KDC-MP2028	K	YES
	KDC-MP228	K	YES
	KDC-MP3029	M	YES
14-SEGMENT DISPLAY	KDC-MP4029/G	M	YES
	KDC-W4031Y	E	YES
	KDC-W409Y	E	YES
	KDC-W431GY	E	YES
CD RECEIVER	KDC-W4531Y	E	YES
	KDC-WF431A	E	YES
	KDC-228	K	YES
	KDC-3029	M	YES
14-SEGMENT DISPLAY	KDC-3029R	M	YES
	KDC-3031AY	E	YES
	KDC-3031GY	E	YES
	KDC-3031Y	E	YES
CD RECEIVER	KDC-309A	E	YES
	KDC-309G	E	YES
	KDC-F331A	E	YES
	KDC-F331G	E	YES
CD RECEIVER	E202	J	YES
	RDT-101	L	YES
	KDC-1028	K	YES
	KDC-128/CR	K	YES
7-SEGMENT DISPLAY	KDC-129/S	M	YES
	KDC-229	M	YES
	KDC-2031SA/Y	E	YES
	KDC-2031SG/Y	E	YES
MD RECEIVER	E303MD	J	YES

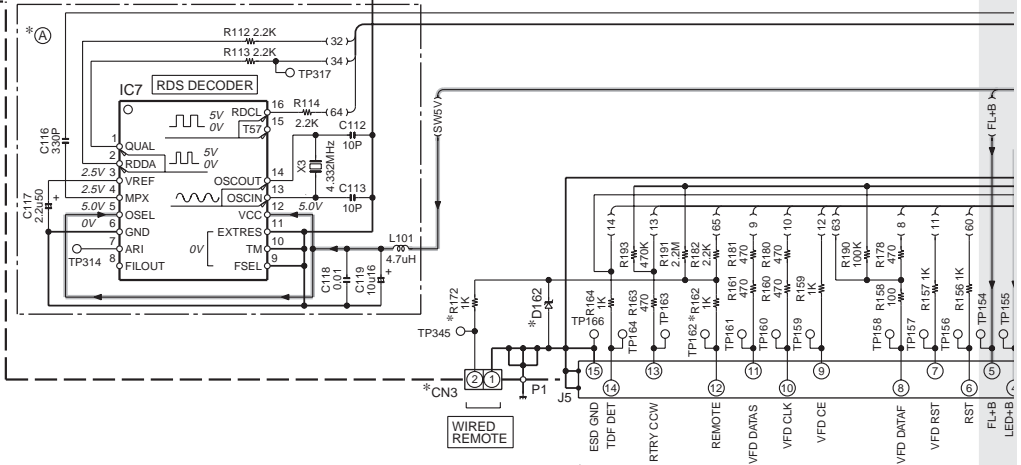

X16-
J1

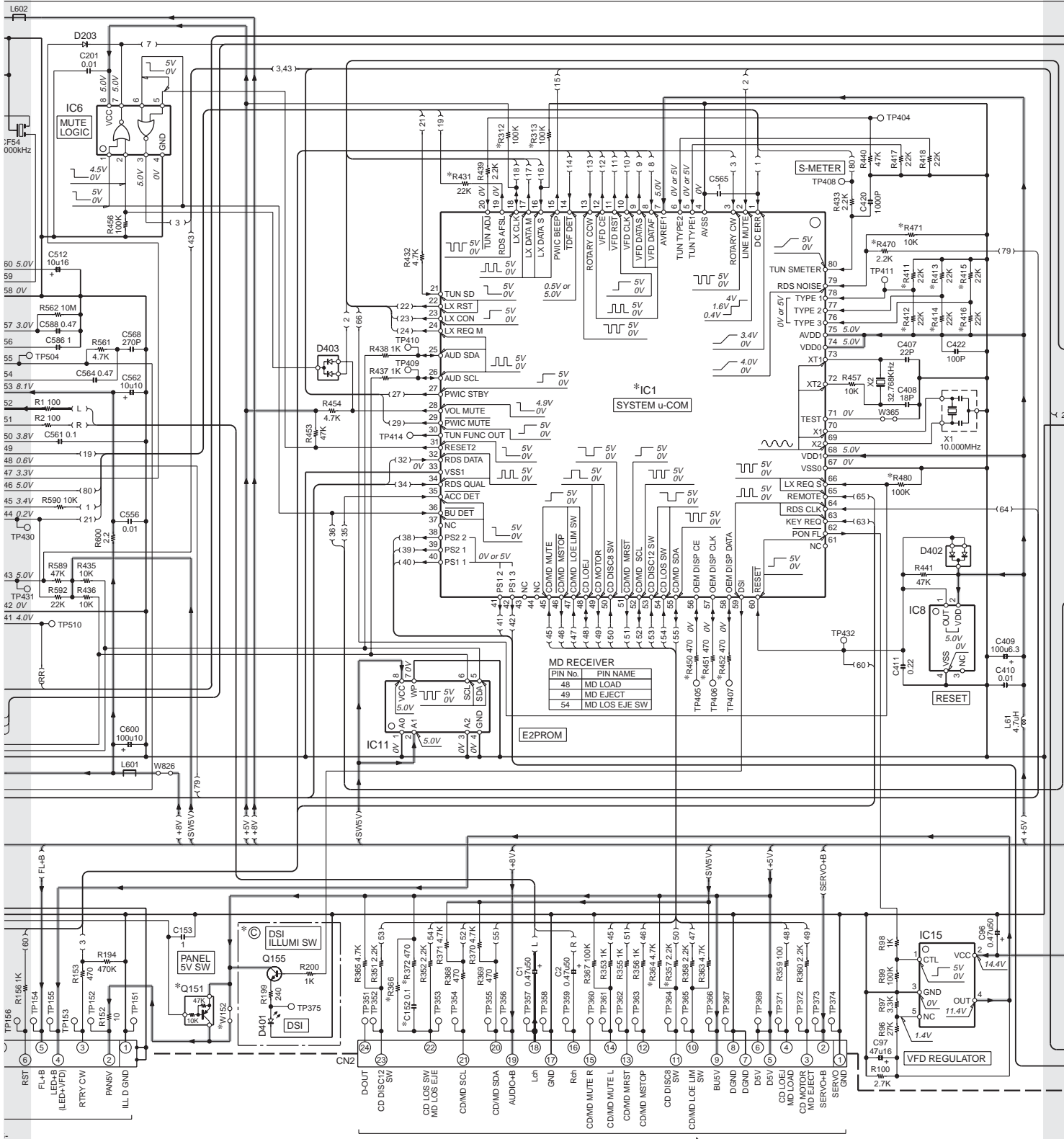

to CD or MD PLAYER UNIT (X32- or X33-) →

2SB1565

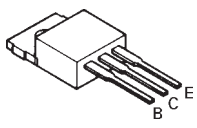

DTA114EE
DTC143TUA
2SA1576A
2SC4617



2SD1858

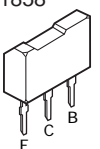

2SC4081

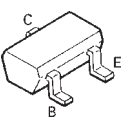

DTA124EUA

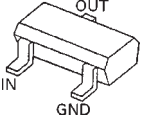

KDC-W4031/W4031Y/W409/W409Y
KDC-W431GY/W4531/W4531Y/WF431A

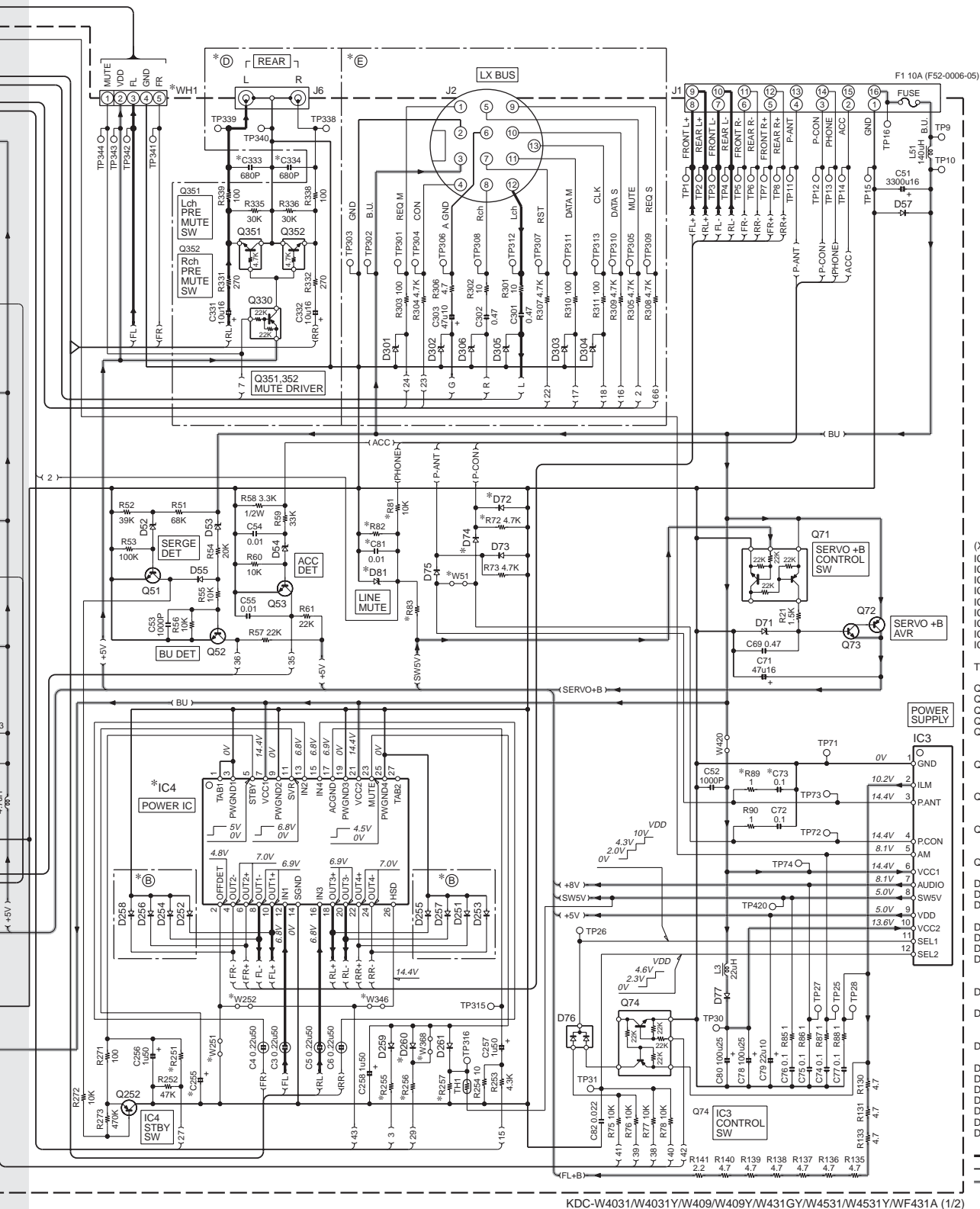

- (X34 -)
- IC1 : *
 - IC3 : BD4912-V4
 - IC4 : *
 - IC6 : TC7W02FU-F
 - IC7 : E-TDA7479AD
 - IC8 : S-80836CNNB-G
 - IC10 : E-TDA7516
 - IC11 : BR24L04FV-W
 - IC15 : BA00CCWT
- TH1 : PRF21BE4710B2
- Q51-53,155 : 2SC4081
Q71,74 : UMC2N
Q72 : 2SB1565(E,F)
Q73 : 2SD1856
Q151 : DT114YUA or KRA307-P or RT1P144M
- Q252 : 2SA1576A or KTA2014P(Y,GR) or 2SA1063A
- Q330 : DTA124EUA or KRA303-P or RT1P241M
- Q351,352 : DTC143TUA or KRC410-P or RT1N430M
- Q501 : HN3G01J(BL)-F
- D3 : IMSA-6801-E
D52,54,305,306 : MAZ4068N-M
D53 : UD2S6.8B or 02D26.8F-Y
D55,261 : 1SS355
D57 : S2V60-A
D71 : MAZ4082N-L
D72,74,75,251-253,255-258 : D1F60-5063 or 1SR154-400
D73,77,254 : AM012NF or 10EDA20
D76,402,403 : DAN202U or KDS121-P or MC2848
D81 : UD2S4.7B or 02D24.7F-Y
D162,301-304 : MAZ4062-L
D203,259,260 : 1SS133
D401 : B30-1567-05
D501 : RN739F
D502,503 : KP231HETR-G
D504 : KV1430STL-G
D506 : HVC383B-E

— SIGNAL LINE
— GND LINE
— +B LINE

KDC-W4031/W4031Y/W409/W409Y/W431GY/W4531/W4531Y/WF431A (1/2)

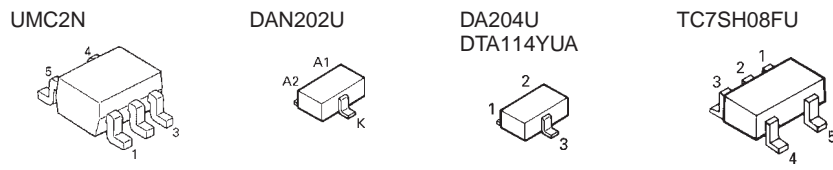

KDC-W4031/W4031Y/W409/W409Y
KDC-W431GY/W4531/W4531Y/WF431A

ANODE CONNECTION

PIN NAME	3GA,3GB	2G	1GA,1GB
P1	—	col (Downside)	S1
P2	2d	2d	2d
P3	1d	1d	1d
P4	2n	2n	2n
P5	1n	1n	1n
P6	2p	2p	2p
P7	1p	1p	1p
P8	2r	2r	2r
P9	1r	1r	1r
P10	2e	2e	2e
P11	1e	1e	1e
P12	2c	2c	2c
P13	1c	1c	1c
P14	2g	2g	2g
P15	1g	1g	1g
P16	2m	2m	2m
P17	1m	1m	1m
P18	2f	2f	2f
P19	1f	1f	1f
P20	2a	2a	2a
P21	1a	1a	1a
P22	2h	2h	2h
P23	1h	1h	1h
P24	2j	2j	2j
P25	1j	1j	1j
P26	2k	2k	2k
P27	1k	1k	1k
P28	2b	2b	2b
P29	1b	1b	1b
P30		col (Upside)	S2
P31		—	S3
P32		—	S4
P33		—	S5
P34	—	—	S6
P35	col	Dp	S7
P36	3d	3d	S8
P37	3n	3n	S9
P38	3p	3p	S10
P39	3r	3r	PTY
P40	3e	3e	
P41	3c	3c	
P42	3g	3g	gh
P43	3m	3m	d
P44	3f	3f	e
P45	3b	3b	c
P46	3k	3k	g
P47	3j	3j	f
P48	3h	3h	b
P49	3a	3a	a

SWITCH UNIT (X16-293x-xx)

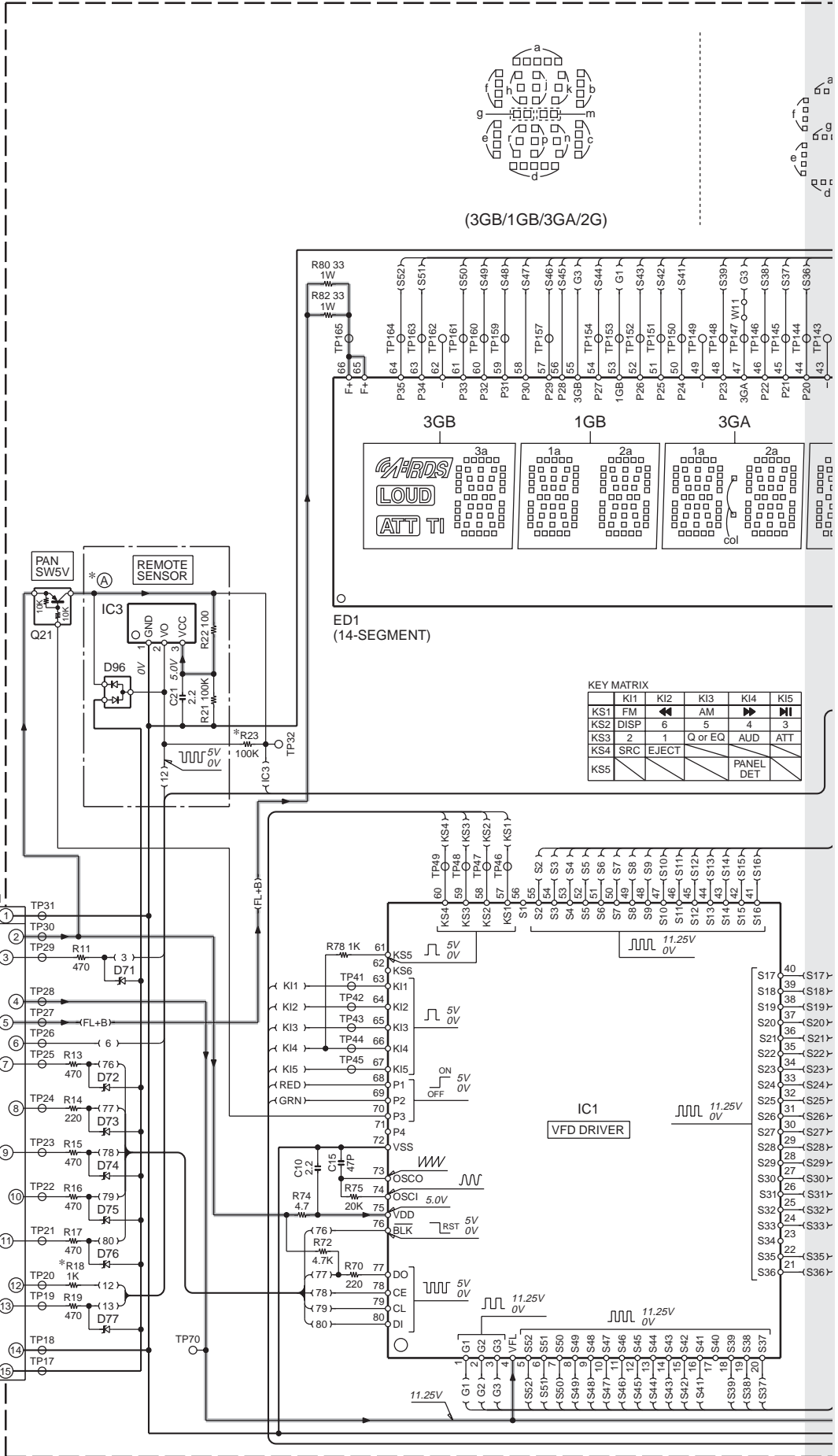

KEY MATRIX

	KI1	KI2	KI3	KI4	KI5
KS1	FM	◀	AM	▶	3
KS2	DISP	6	5	4	3
KS3	2	1	Q or EQ	AUD	ATT
KS4	SRC	EJECT			
KS5				PANEL DET	

CAUTION : For continued safety, replace safety critical components only with manufacturer's recommended parts (refer to parts list).
 ⚠ Indicates safety critical components. To reduce the risk of electric shock, leakage-current or resistance measurements shall be carried out (exposed parts are acceptably insulated from the supply circuit) before the appliance is returned to the customer.

• DC voltages are as measured with a high impedance voltmeter. Values may vary slightly due to variations between individual instruments or/and units.

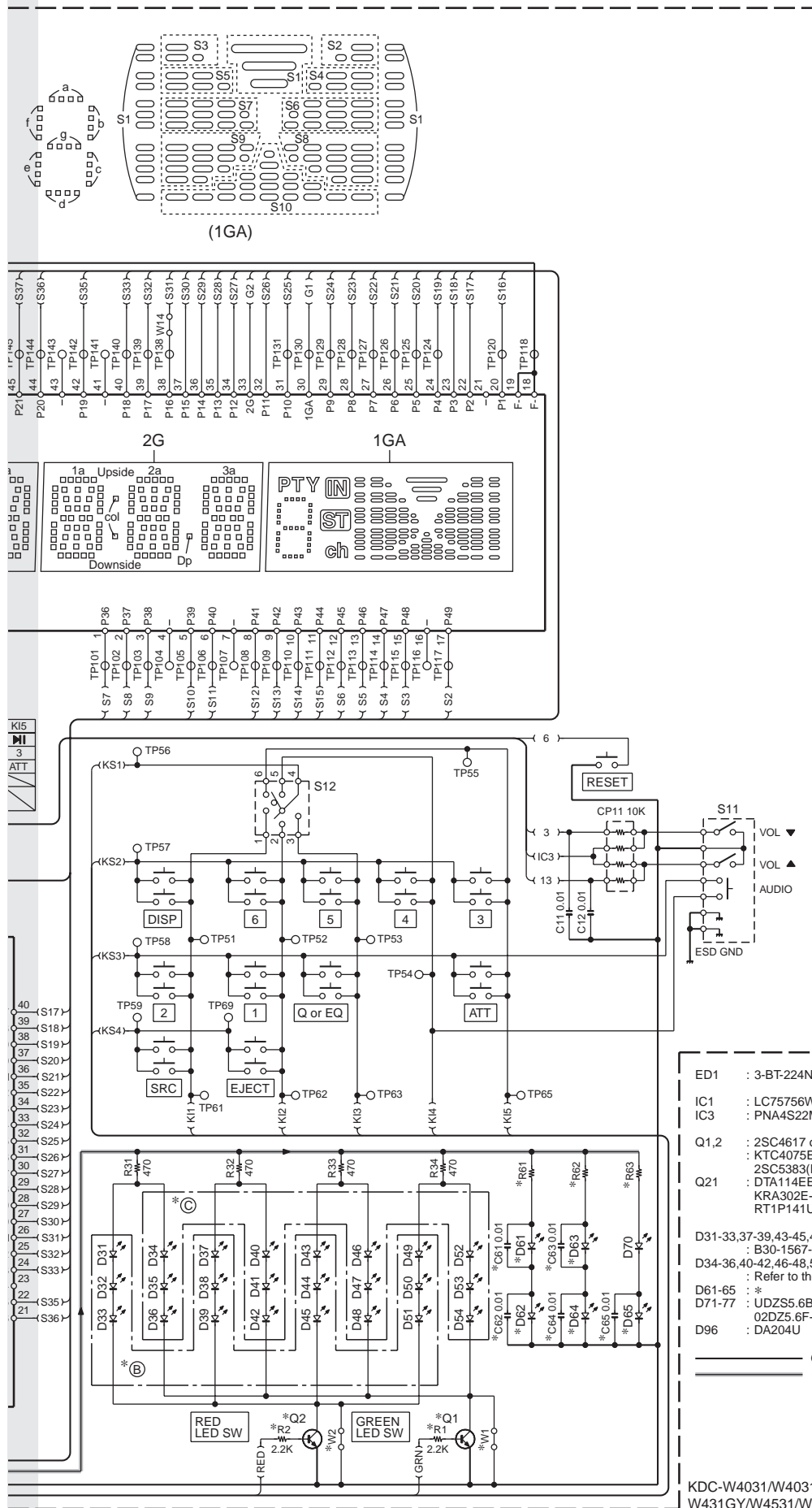

MODEL NAME	DESTI- NATION	UNIT No.	(A)	(B)	(C)	C61-65	D61-65	Q1,2	R1,2	R18	R23	R61	R62	R63	W1	W2
E303/S	J	0-01	YES	—	YES	YES	B30-1729-05	—	—	—	—	300	300	470	—	—
KDC-IP2028	K	0-10	YES	YES	YES	YES	B30-1729-05	—	—	YES	—	300	300	470	YES	—
KDC-IP3029	M	0-23	YES	—	YES	—	B30-1533-05	—	—	—	YES	620	560	560	YES	—
KDC-IP4029/G	M	0-21	YES	—	YES	—	B30-1729-05	—	—	—	—	300	300	470	YES	—
KDC-W4031Y	E	2-72	—	YES	YES	YES	B30-1729-05	YES	YES	YES	YES	300	300	470	—	—
KDC-W409Y	E	2-74	—	YES	YES	YES	B30-1533-05	—	—	—	—	YES	YES	620	560	560
KDC-W431GY	E	2-74	—	YES	YES	YES	B30-1533-05	—	—	—	—	YES	YES	620	560	560
KDC-W4531Y	E	2-71	YES	YES	YES	YES	B30-1729-05	YES	YES	YES	YES	300	300	470	—	—
KDC-WF431A	E	2-75	—	YES	YES	YES	B30-1729-05	—	—	—	—	YES	YES	620	560	560
KDC-228	K	0-22	YES	YES	—	—	B30-1567-05	—	—	—	—	680	680	—	—	—
KDC-2029	M	0-23	YES	—	YES	—	B30-1533-05	—	—	—	—	620	560	560	YES	—
KDC-3029	M	0-22	YES	YES	—	—	B30-1567-05	—	—	—	—	680	680	—	—	—
KDC-3029R	M	0-22	YES	YES	—	—	B30-1567-05	—	—	—	—	680	680	—	—	—
KDC-3031AY	E	2-73	—	YES	—	—	B30-1567-05	—	—	—	—	680	680	—	—	—
KDC-3031GY	E	2-74	—	YES	—	—	B30-1533-05	—	—	—	—	620	560	560	YES	—
KDC-309A	E	2-74	—	YES	—	—	B30-1567-05	—	—	—	—	680	680	—	—	—
KDC-309B	E	2-73	—	YES	—	—	B30-1533-05	—	—	—	—	620	560	560	YES	—
KDC-F331A	E	2-73	—	YES	—	—	B30-1567-05	—	—	—	—	680	680	—	—	—
KDC-F331G	E	2-74	—	YES	—	—	B30-1533-05	—	—	—	—	620	560	560	YES	—
E303MD	J	0-02	—	YES	YES	YES	B30-1729-05	—	—	—	—	300	300	470	YES	—

(X16-293x-xx)

- ED1 : 3-BT-224N
- IC1 : LC75756W
- IC3 : PNA4S22M
- Q1,2 : 2SC4617 or KTC4075EP(Y,GR or 2SC5383(E,F)
- Q21 : DTA114EE or KRA302E-P or RT1P141U
- D31-33,37-39,43-45,49-51,70 : B30-1567-05 (COLOR:RED)
- D34-36,40-42,46-48,52-54 : Refer to the parts list.
- D61-65 : *
- D71-77 : UDZS5.6B or 02DZ5.6F-Y
- D96 : DA204U



KDC-W4031/W4031Y/W409/W409Y/
W431GY/W4531/W4531Y/WF431A (2/2)

KDC-W4031/W4031Y/W409/W409Y
KDC-W431GY/W4531/W4531Y/WF431A

CD PLAYER UNIT (X32-5500-00)

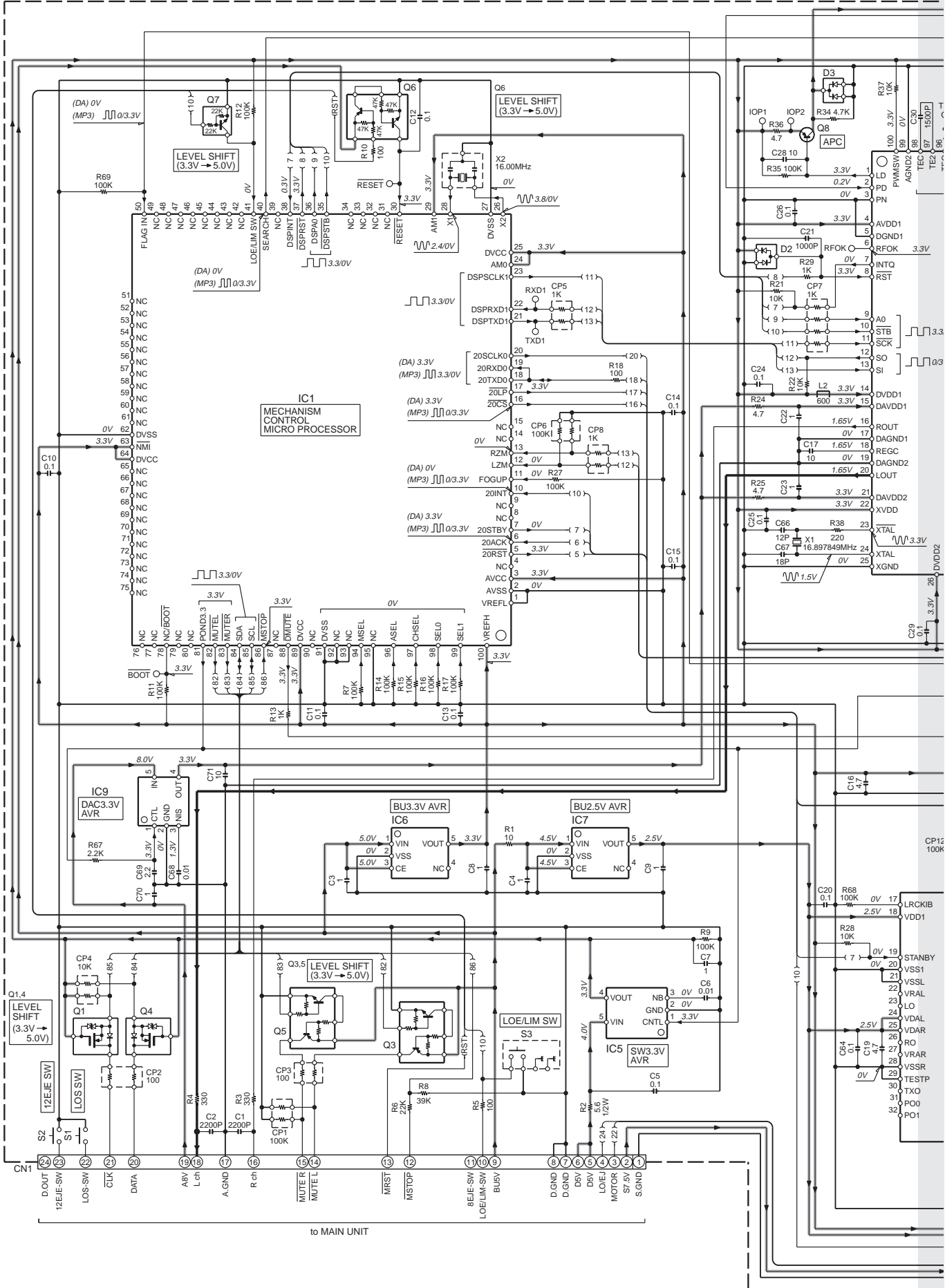

to MAIN UNIT

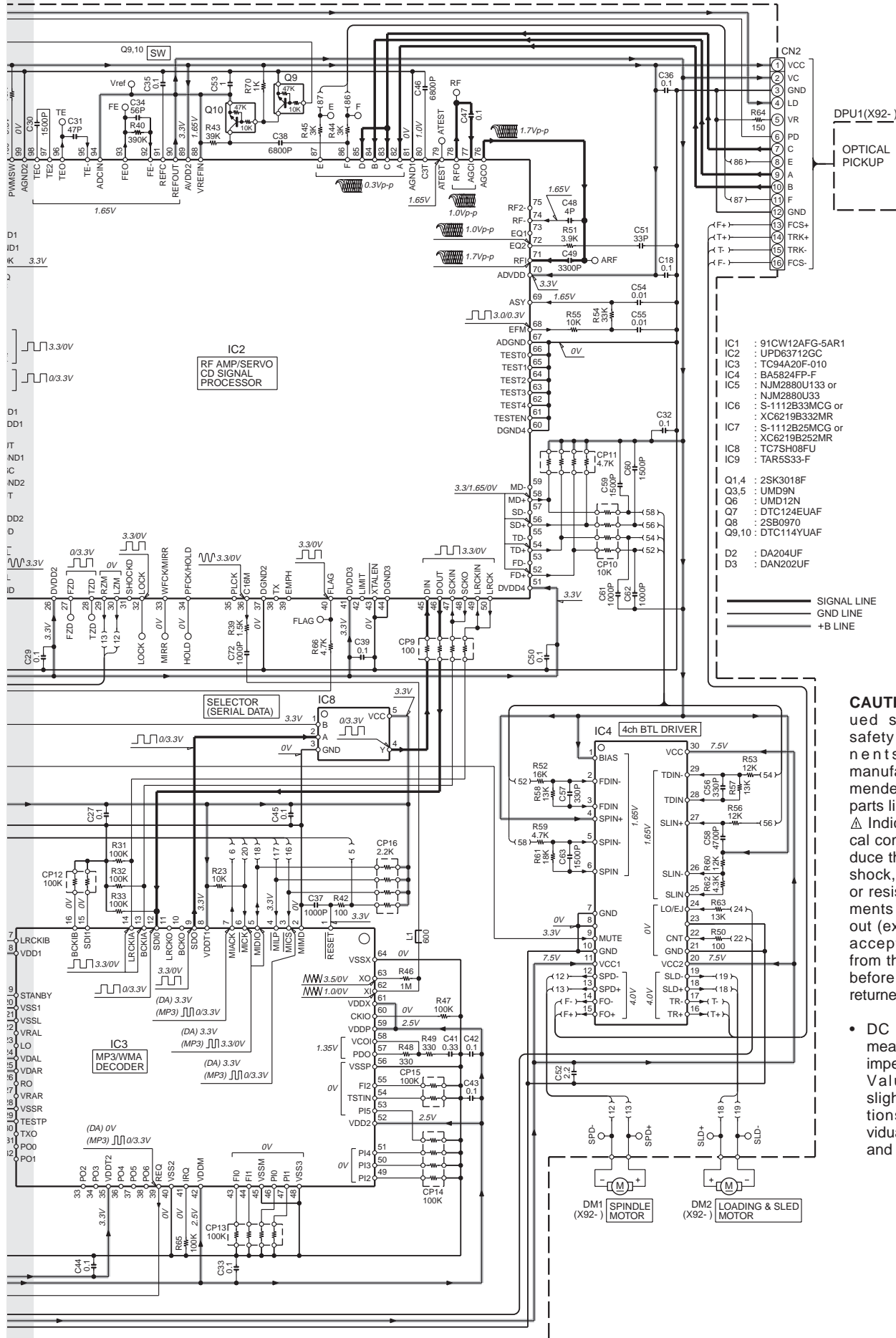

- IC1 : 91CW12AFG-5AR1
 - IC2 : UPD63712GC
 - IC3 : TC94A20F-010
 - IC4 : BA5824FP-F
 - IC5 : NJM2880U133 or NJM2880U33
 - IC6 : S-1112B33MCG or XC6219B332MR
 - IC7 : S-1112B25MCG or XC6219B252MR
 - IC8 : TC7SH08FU
 - IC9 : TAR5S33-F
- Q1,4 : 2SK3018F
 - Q3,5 : UMD9N
 - Q6 : UMD12N
 - Q7 : DTC124EUAF
 - Q8 : 2SB0970
 - Q9,10 : DTC114YUAF
- D2 : DA204UF
 - D3 : DAN202UF

CAUTION : For continued safety, replace safety critical components only with manufacturer's recommended parts (refer to parts list).
 ⚠ Indicates safety critical components. To reduce the risk of electric shock, leakage-current or resistance measurements shall be carried out (exposed parts are acceptably insulated from the supply circuit) before the appliance is returned to the customer.

- DC voltages are as measured with a high impedance voltmeter. Values may vary slightly due to variations between individual instruments or/and units.

EXPLODED VIEW (CD MECHANISM)

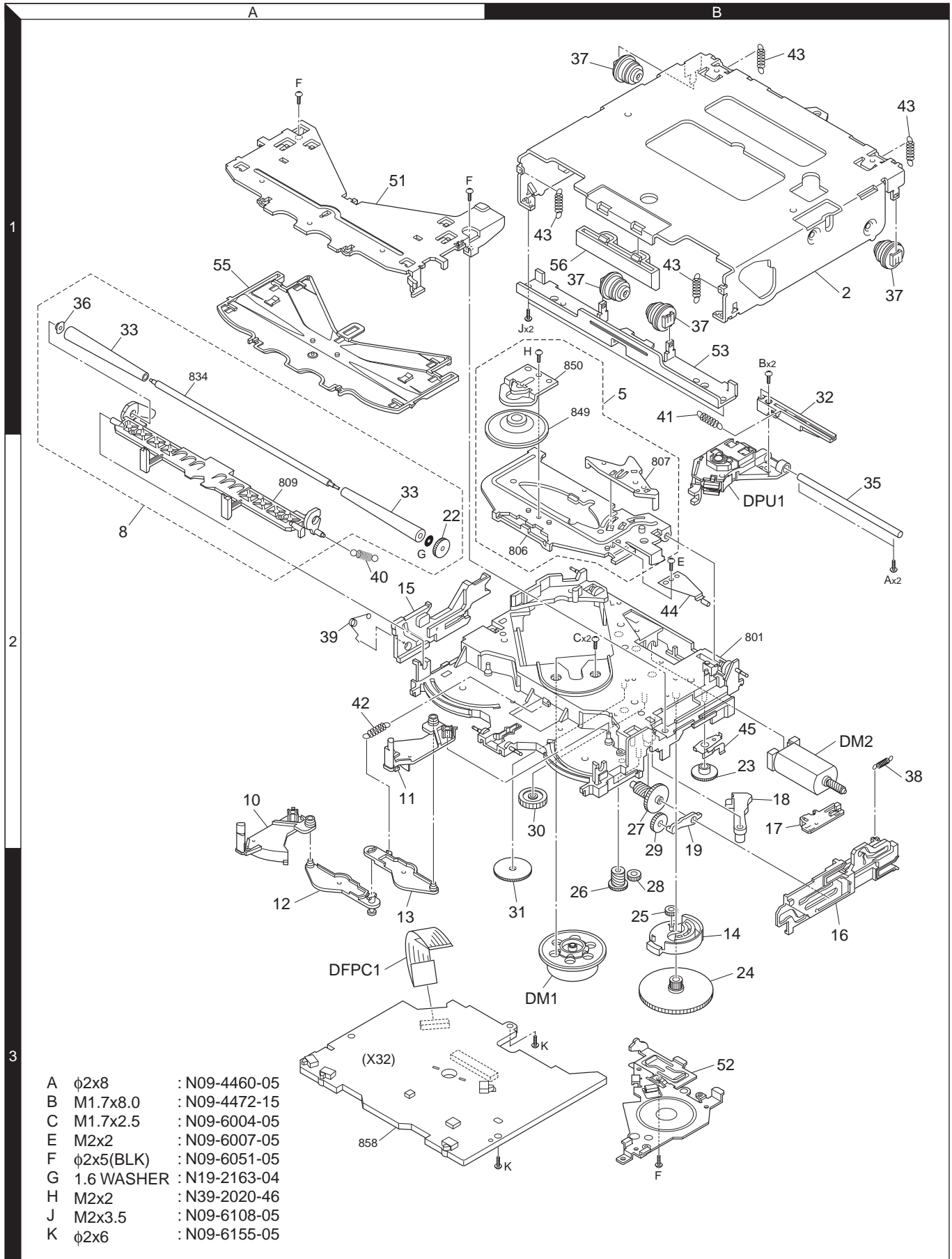

EXPLODED VIEW (UNIT)

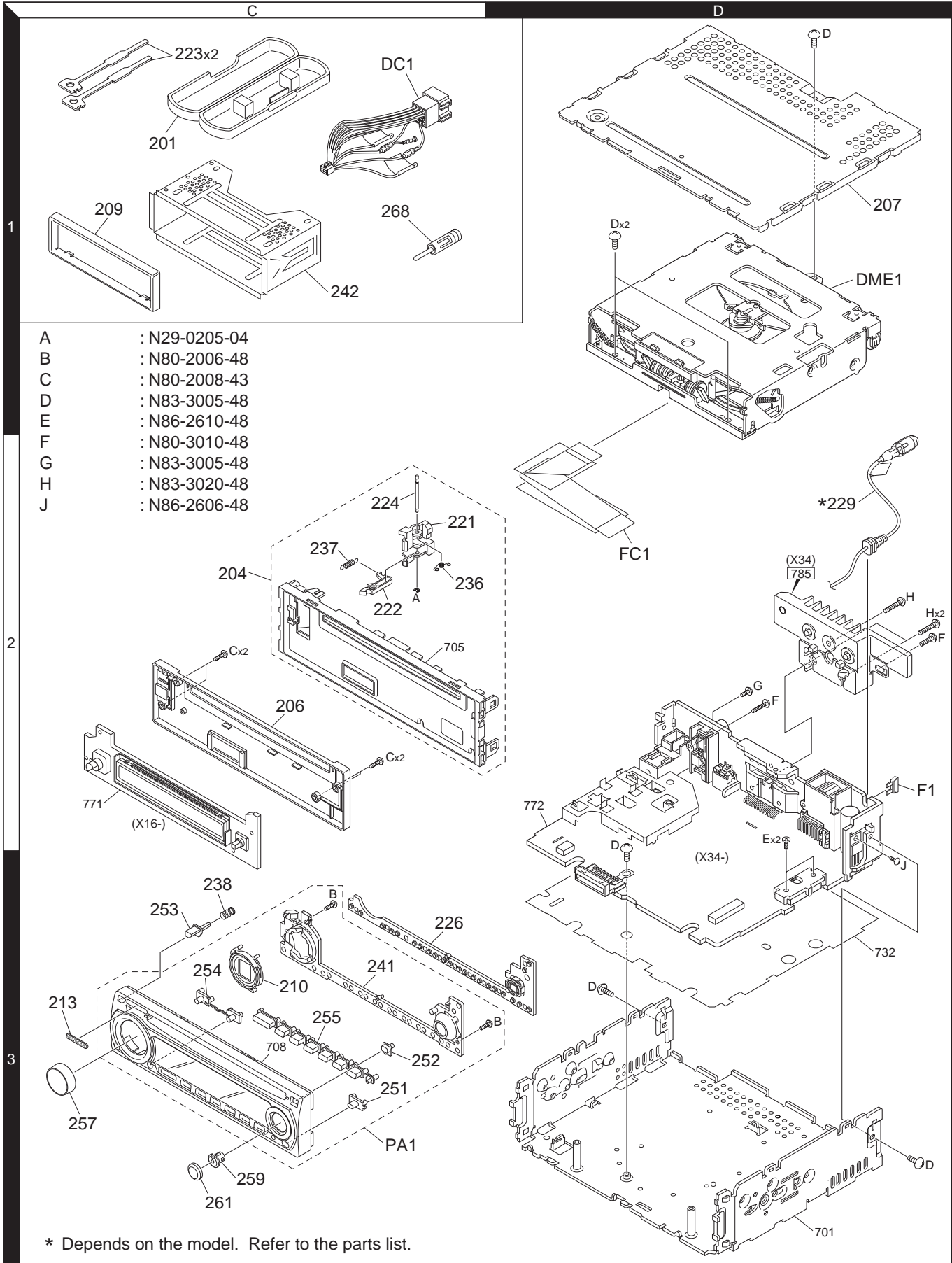

Parts with the exploded numbers larger than 700 are not supplied.

PARTS LIST

* New parts

Parts without **Parts No.** are not supplied.

Les articles non mentionnés dans le **Parts No.** ne sont pas fournis.

Teile ohne **Parts No.** werden nicht geliefert.

Ref. No.	A d d	N e w	Parts No.	Description	Desti- nation
KDC-W4031/W4031Y/W409/W409Y/W431GY/W4531/W4531Y/WF431A					
201	1C	*	A02-2736-03	PLASTIC CABINET ASSY	
204	2C		A22-2863-13	SUB PANEL ASSY	
206	2C	*	A46-1815-01	REAR COVER	
207	1D	*	A52-0804-12	TOP PLATE	
PA1	3C	*	A64-3454-02	PANEL ASSY	EE7
PA1	3C	*	A64-3455-02	PANEL ASSY	E1E8
PA1	3C	*	A64-3456-02	PANEL ASSY	E2E9
PA1	3C	*	A64-3457-02	PANEL ASSY	E3
PA1	3C	*	A64-3466-02	PANEL ASSY	E6
-			B46-0100-50	WARRANTY CARD	EE1E2
-			B46-0100-50	WARRANTY CARD	E6
-			B46-0182-14	ID CARD	E1E2E6
-			B46-0606-04	ID CARD	E3E8E9
-			B46-0612-14	ID CARD	EE7
-		*	B64-2932-00	INST. MANUAL (ENGLISH)	EE1E2
-		*	B64-2932-00	INST. MANUAL (ENGLISH)	E3E7E8
-		*	B64-2932-00	INST. MANUAL (ENGLISH)	E9
-		*	B64-2933-00	INST. MANUAL (FRE, GER)	EE1E2
-		*	B64-2933-00	INST. MANUAL (FRE, GER)	E6
-		*	B64-2934-00	INST. MANUAL (DUT, ITA)	EE1E2
-		*	B64-2935-00	INST. MANUAL (SPA, POR)	EE1E2
-		*	B64-2936-00	INST. MANUAL (RUSSIAN)	E3E7E8
-		*	B64-2936-00	INST. MANUAL (RUSSIAN)	E9
-		*	B64-2939-00	INST. MANUAL (POL, CZE, HUN)	E8
-		*	B64-2940-00	INST. MANUAL (CRO, SLO)	E8
209	1C	*	B07-3122-01	ESCUTCHEON	EE1E3
209	1C	*	B07-3122-01	ESCUTCHEON	E6E7E8
209	1C	*	B07-3123-01	ESCUTCHEON	E2E9
210	3C	*	B19-2304-03	LIGHTING BOARD	
213	3C		B43-1518-04	BADGE	
221	2C		D10-4446-03	LEVER	
222	2C		D10-4447-03	LEVER	
223	1C		D10-4589-04	LEVER	
224	2C		D21-2329-04	SHAFT	
226	3C	*	E29-2027-02	CONDUCTIVE RUBBER	
229	2D	*	E30-6402-05	CORD WITH CONNECTOR	EE1E2
229	2D	*	E30-6402-05	CORD WITH CONNECTOR	E6E7E8
229	2D	*	E30-6402-05	CORD WITH CONNECTOR	E9
△ DC1	1C	*	E30-6413-05	DC CORD	
△ DC1	1C	*	E30-6427-05	DC CORD	
FC1	2D	*	E39-0718-05	FLAT CABLE	
△ F1	2D		F52-0006-05	FUSE (MINI BLADE TYPE) (10A)	
△ F1	2D		F52-0023-05	FUSE (MINI BLADE TYPE) (10A)	
236	2C		G01-2987-04	TORSION COIL SPRING	
237	2C		G01-3096-04	EXTENSION SPRING	
238	3C	*	G01-3244-04	COMPRESSION SPRING	
-		*	H10-4919-12	POLYSTYRENE FOAMED FIXTURE	
-			H25-0329-04	PROTECTION BAG (280X450X0.03)	E7E8E9
-			H25-0337-04	PROTECTION BAG (180X300X0.03)	
-			H25-1111-04	PROTECTION BAG (280X450X0.03)	EE1E2
-			H25-1111-04	PROTECTION BAG (280X450X0.03)	E3E6

Ref. No.	A d d	N e w	Parts No.	Description	Desti- nation
-		*	H54-3298-03	ITEM CARTON CASE (KDC-W4531)	E
-		*	H54-3299-03	ITEM CARTON CASE (KDC-W4031)	E1
-		*	H54-3300-03	ITEM CARTON CASE (KDC-W409)	E2
-		*	H54-3301-03	ITEM CARTON CASE (KDC-W431GY)	E3
-		*	H54-3310-03	ITEM CARTON CASE (KDC-W4531Y)	E7
-		*	H54-3311-03	ITEM CARTON CASE (KDC-W4031Y)	E8
-		*	H54-3312-03	ITEM CARTON CASE (KDC-W409Y)	E9
-		*	H54-3361-03	ITEM CARTON CASE (KDC-WF431A)	E6
241	3C	*	J19-7046-01	HOLDER	
242	1C		J21-9716-03	MOUNTING HARDWARE ASSY	
251	3C	*	K24-4279-04	PUSH KNOB (AUTO or TI)	
252	3C	*	K24-4280-04	PUSH KNOB (EJECT)	
253	3C	*	K24-4281-04	PUSH KNOB (RELEASE)	
254	3C	*	K25-1689-03	PUSH KNOB (ATT/Q)	
255	3C	*	K25-1690-02	PUSH KNOB (SRC/PRESET/RESET)	E3E6
255	3C	*	K25-1691-02	PUSH KNOB (SRC/PRESET/RESET)	EE1E2
255	3C	*	K25-1691-02	PUSH KNOB (SRC/PRESET/RESET)	E7E8E9
257	3C	*	K29-7132-03	KNOB ASSY (VOL)	
259	3C	*	K29-7134-03	KNOB BASE (FM/AM)	
261	3C	*	K29-7139-03	KEY TOP (FM/AM)	EE1E2
261	3C	*	K29-7139-03	KEY TOP (FM/AM)	E7E8E9
261	3C	*	K29-7140-03	KEY TOP (FM/AM)	E3E6
A	2C		N29-0205-04	RETAINING RING (1.5)	
B	3C		N80-2006-48	PAN HEAD TAPTITE SCREW	
C	2C		N80-2008-43	PAN HEAD TAPTITE SCREW	
D	3D	*	N83-3005-48	PAN HEAD TAPTITE SCREW	
E	2D	*	N86-2610-48	BINDING HEAD TAPTITE SCREW	
268	1C		T90-0523-05	ANTENNA ADAPTOR	
268	1C		T90-0534-05	ANTENNA ADAPTOR	
DME1	1D		X92-4850-00	MECHANISM ASSY	
SWITCH UNIT (X16-2932-7x)					
D31-33			B30-1567-05	LED (RED)	EE1E2
D31-33			B30-1567-05	LED (RED)	E6E7E8
D31-33			B30-1567-05	LED (RED)	E9
D34-36			B30-1533-05	LED (PG)	EE1E2
D34-36			B30-1533-05	LED (PG)	E3E7E8
D34-36			B30-1533-05	LED (PG)	E9
D37-39			B30-1567-05	LED (RED)	EE1E2
D37-39			B30-1567-05	LED (RED)	E6E7E8
D37-39			B30-1567-05	LED (RED)	E9
D40-42			B30-1533-05	LED (PG)	EE1E2
D40-42			B30-1533-05	LED (PG)	E3E7E8
D40-42			B30-1533-05	LED (PG)	E9
D43-45			B30-1567-05	LED (RED)	EE1E2
D43-45			B30-1567-05	LED (RED)	E6E7E8
D43-45			B30-1567-05	LED (RED)	E9
D46-48			B30-1533-05	LED (PG)	EE1E2
D46-48			B30-1533-05	LED (PG)	E3E7E8
D46-48			B30-1533-05	LED (PG)	E9
D49-51			B30-1567-05	LED (RED)	EE1E2
D49-51			B30-1567-05	LED (RED)	E6E7E8
D49-51			B30-1567-05	LED (RED)	E9

E : KDC-W4531 E1 : KDC-W4031 E2 : KDC-W409 E3 : KDC-W431GY E6 : KDC-WF431A

E7 : KDC-W4531Y E8 : KDC-W4031Y E9 : KDC-W409Y

28 (E : Europe K : North America M : Other Areas W : Without Europe)

△ Indicates safety critical components.

PARTS LIST

SWITCH UNIT (X16-2932-7x)

Ref. No.	Add	New	Parts No.	Description	Destination
D52-54			B30-1533-05	LED (PG)	EE1E2
D52-54			B30-1533-05	LED (PG)	E3E7E8
D52-54			B30-1533-05	LED (PG)	E9
D61-65			B30-1533-05	LED (PG)	E3
D61-65		*	B30-1729-05	LED (BLUE)	EE1E2
D61-65		*	B30-1729-05	LED (BLUE)	E6E7E8
D61-65		*	B30-1729-05	LED (BLUE)	E9
D70			B30-1567-05	LED (RED)	
C10			CK73GB0J225K	CHIP C 2.2UF K	
C11,12			CK73GB1H103K	CHIP C 0.010UF K	
C15			CC73GCH1H470J	CHIP C 47PF J	
C21			CK73FB1A225K	CHIP C 2.2UF K	EE7
C61-65			CK73GB1H103K	CHIP C 0.010UF K	EE1E2
C61-65			CK73GB1H103K	CHIP C 0.010UF K	E6E7E8
C61-65			CK73GB1H103K	CHIP C 0.010UF K	E9
J1		*	E59-0840-05	RECTANGULAR PLUG	
CP11			RK74HB1J103J	CHIP-COM 10K J 1/16W	
R1,2			RK73GB2A222J	CHIP R 2.2K J 1/10W	EE1E2
R1,2			RK73GB2A222J	CHIP R 2.2K J 1/10W	E7E8E9
R11			RK73GB2A471J	CHIP R 470 J 1/10W	
R13			RK73GB2A471J	CHIP R 470 J 1/10W	
R14			RK73GB2A221J	CHIP R 220 J 1/10W	
R15-17			RK73GB2A471J	CHIP R 470 J 1/10W	
R18			RK73GB2A102J	CHIP R 1.0K J 1/10W	
R19			RK73GB2A471J	CHIP R 470 J 1/10W	
R21			RK73GB2A104J	CHIP R 100K J 1/10W	EE7
R22			RK73GB2A101J	CHIP R 100 J 1/10W	EE7
R23			RK73GB2A104J	CHIP R 100K J 1/10W	E1E2E3
R23			RK73GB2A104J	CHIP R 100K J 1/10W	E6E8E9
R31-34			RK73FB2B471J	CHIP R 470 J 1/8W	
R61			RK73EB2E621J	CHIP R 620 J 1/4W	E3
R61,62			RK73EB2E301J	CHIP R 300 J 1/4W	EE1E2
R61,62			RK73EB2E301J	CHIP R 300 J 1/4W	E6E7E8
R61,62			RK73EB2E301J	CHIP R 300 J 1/4W	E9
R62,63			RK73EB2E561J	CHIP R 560 J 1/4W	E3
R63			RK73EB2E471J	CHIP R 470 J 1/4W	EE1E2
R63			RK73EB2E471J	CHIP R 470 J 1/4W	E6E7E8
R63			RK73EB2E471J	CHIP R 470 J 1/4W	E9
R70			RK73GB2A221J	CHIP R 220 J 1/10W	
R72			RK73GB2A472J	CHIP R 4.7K J 1/10W	
R74			RK73GB2A4R7J	CHIP R 4.7 J 1/10W	
R75			RK73GB2A203J	CHIP R 20K J 1/10W	
R78			RK73GB2A102J	CHIP R 1.0K J 1/10W	
R80		*	RK73SB3A330J	CHIP R 33 J 1W	
R82		*	RK73SB3A330J	CHIP R 33 J 1W	
W1			R92-1252-05	CHIP R 0 OHM J 1/16W	E3
W2			R92-1252-05	CHIP R 0 OHM J 1/16W	E6
W11			R92-1252-05	CHIP R 0 OHM J 1/16W	
W14			R92-1252-05	CHIP R 0 OHM J 1/16W	
S12			S70-0106-05	TACT SWITCH	
S11		*	T99-0457-05	ROTARY ENCODER	

Ref. No.	Add	New	Parts No.	Description	Destination
D71-77			UDZS5.6B	ZENER DIODE	
D71-77		*	02DZ5.6F-Y	ZENER DIODE	
D96			DA204U	DIODE	EE7
ED1		*	3-BT-224N	FLUORESCENT INDICATOR TUBE	
IC1		*	LC75756W	MOS-IC	
IC3			PNA4S22M	ANALOGUE IC	EE7
Q1,2		*	KTC4075EP(Y,GR)	TRANSISTOR	EE1E2
Q1,2		*	KTC4075EP(Y,GR)	TRANSISTOR	E7E8E9
Q1,2			2SC4617	TRANSISTOR	EE1E2
Q1,2			2SC4617	TRANSISTOR	E7E8E9
Q1,2		*	2SC5383(E,F)	TRANSISTOR	EE1E2
Q1,2		*	2SC5383(E,F)	TRANSISTOR	E7E8E9
Q21			DTA114EE	DIGITAL TRANSISTOR	
Q21		*	KRA302E-P	DIGITAL TRANSISTOR	
Q21			RT1P141U	TRANSISTOR	
CD PLAYER UNIT (X32-5500-00)					
C1,2			CK73GB1H222K	CHIP C 2200PF K	
C3,4			CK73GB0J105K	CHIP C 1.0UF K	
C5			CK73GB1C104K	CHIP C 0.10UF K	
C6			CK73GB1H103K	CHIP C 0.010UF K	
C7-9			CK73GB0J105K	CHIP C 1.0UF K	
C10-15			CK73GB1C104K	CHIP C 0.10UF K	
C16			CK73FB0J475K	CHIP C 4.7UF K	
C17			CK73FB0J106M	CHIP C 10UF M	
C18			CK73GB1C104K	CHIP C 0.10UF K	
C19			CK73FB0J475K	CHIP C 4.7UF K	
C20			CK73GB1C104K	CHIP C 0.10UF K	
C21			CK73GB1H102K	CHIP C 1000PF K	
C22,23			CK73GB0J105K	CHIP C 1.0UF K	
C24-27			CK73GB1C104K	CHIP C 0.10UF K	
C28			CK73FB0J106M	CHIP C 10UF M	
C29			CK73GB1C104K	CHIP C 0.10UF K	
C30			CK73GB1H152K	CHIP C 1500PF K	
C31			CC73GCH1H470J	CHIP C 47PF J	
C32,33			CK73GB1C104K	CHIP C 0.10UF K	
C34			CC73GCH1H560J	CHIP C 56PF J	
C35,36			CK73GB1C104K	CHIP C 0.10UF K	
C37			CK73GB1H102K	CHIP C 1000PF K	
C38			CK73GB1H682K	CHIP C 6800PF K	
C39			CK73GB1C104K	CHIP C 0.10UF K	
C41			CK73GB1A334K	CHIP C 0.33UF K	
C42-45			CK73GB1C104K	CHIP C 0.10UF K	
C46			CK73GB1H682K	CHIP C 6800PF K	
C47			CK73GB1C104K	CHIP C 0.10UF K	
C48			CC73GCH1H040C	CHIP C 4.0PF C	
C49			CK73GB1H332K	CHIP C 3300PF K	
C50			CK73GB1C104K	CHIP C 0.10UF K	
C51			CC73GCH1H330J	CHIP C 33PF J	
C52			CK73FB1A225K	CHIP C 2.2UF K	
C53			CK73GB0J105K	CHIP C 1.0UF K	
C54,55			CK73GB1H103K	CHIP C 0.010UF K	
C56,57			CK73GB1H331K	CHIP C 330PF K	
C58			CK73GB1H472K	CHIP C 4700PF K	
C59,60			CK73GB1H152K	CHIP C 1500PF K	
C61,62			CK73GB1H102K	CHIP C 1000PF K	

E : KDC-W4531 E1 : KDC-W4031 E2 : KDC-W409 E3 : KDC-W431GY E6 : KDC-WF431A
E7 : KDC-W4531Y E8 : KDC-W4031Y E9 : KDC-W409Y
(E : Europe K : North America M : Other Areas W : Without Europe)

△ Indicates safety critical components.

PARTS LIST

CD PLAYER UNIT (X32-5500-00)

Ref. No.	A d d	N e w	Parts No.	Description	Desti- nation
C63			CK73GB1H152K	CHIP C 1500PF K	
C64			CK73GB1C104K	CHIP C 0.10UF K	
C66			CC73GCH1H120J	CHIP C 12PF J	
C67			CC73GCH1H180J	CHIP C 18PF J	
C68			CK73GB1H103K	CHIP C 0.010UF K	
C69			CK73FB1A225K	CHIP C 2.2UF K	
C70			CK73FB1A105K	CHIP C 1.0UF K	
C71			CK73FB0J106M	CHIP C 10UF M	
C72			CK73GB1H102K	CHIP C 1000PF K	
CN1			E41-2083-05	FLAT CABLE CONNECTOR	
CN2			E41-2068-05	FLAT CABLE CONNECTOR	
CN2			E41-2085-15	FLAT CABLE CONNECTOR	
L1,2			L92-0386-05	CHIP FERRITE	
X1			L77-2808-05	CRYSTAL RESONATOR (16.897849MHZ)	
X2			L78-0896-05	RESONATOR (16.00MHZ)	
CP1			RK74GA1J104J	CHIP-COM 100K J 1/16W	
CP2,3			RK74GA1J101J	CHIP-COM 100 J 1/16W	
CP4			RK74GA1J103J	CHIP-COM 10K J 1/16W	
CP5			RK74GA1J102J	CHIP-COM 1.0K J 1/16W	
CP6			RK74GA1J104J	CHIP-COM 100K J 1/16W	
CP7			RK74GB1J102J	CHIP-COM 1.0K J 1/16W	
CP8			RK74GA1J102J	CHIP-COM 1.0K J 1/16W	
CP9			RK74GB1J101J	CHIP-COM 100 J 1/16W	
CP10			RK74GB1J103J	CHIP-COM 10K J 1/16W	
CP11			RK74GB1J472J	CHIP-COM 4.7K J 1/16W	
CP12			RK74GA1J104J	CHIP-COM 100K J 1/16W	
CP13,14			RK74GB1J104J	CHIP-COM 100K J 1/16W	
CP15			RK74GA1J104J	CHIP-COM 100K J 1/16W	
CP16			RK74GB1J222J	CHIP-COM 2.2K J 1/16W	
R1			RK73GB2A100J	CHIP R 10 J 1/10W	
R2			R92-3494-05	CHIP R 5.6 F 1/2W	
R3,4			RK73FB2B331J	CHIP R 330 J 1/8W	
R5			RK73GB2A101J	CHIP R 100 J 1/10W	
R6			RN73GH1J223D	CHIP R 22K D 1/16W	
R7			RK73GB2A104J	CHIP R 100K J 1/10W	
R8			RN73GH1J393D	CHIP R 39K D 1/16W	
R9			RK73GB2A104J	CHIP R 100K J 1/10W	
R10			RK73GB2A101J	CHIP R 100 J 1/10W	
R11,12			RK73GB2A104J	CHIP R 100K J 1/10W	
R13			RK73GB2A102J	CHIP R 1.0K J 1/10W	
R14-17			RK73GB2A104J	CHIP R 100K J 1/10W	
R18			RK73GB2A101J	CHIP R 100 J 1/10W	
R21-23			RK73GB2A103J	CHIP R 10K J 1/10W	
R24,25			RK73GB2A4R7J	CHIP R 4.7 J 1/10W	
R27			RK73GB2A104J	CHIP R 100K J 1/10W	
R28			RK73GB2A103J	CHIP R 10K J 1/10W	
R29			RK73GB2A102J	CHIP R 1.0K J 1/10W	
R31-33			RK73GB2A104J	CHIP R 100K J 1/10W	
R34			RK73GB2A472J	CHIP R 4.7K J 1/10W	
R35			RK73GB2A104J	CHIP R 100K J 1/10W	
R36			RK73FB2B4R7J	CHIP R 4.7 J 1/8W	
R37			RK73GB2A103J	CHIP R 10K J 1/10W	
R38			RK73GB2A221J	CHIP R 220 J 1/10W	
R39			RK73GB2A152J	CHIP R 1.5K J 1/10W	

Ref. No.	A d d	N e w	Parts No.	Description	Desti- nation
R40			RK73GB2A394J	CHIP R 390K J 1/10W	
R42			RK73GB2A101J	CHIP R 100 J 1/10W	
R43			RK73GB2A393J	CHIP R 39K J 1/10W	
R44,45			RK73GB2A302J	CHIP R 3.0K J 1/10W	
R46			RK73GB2A105J	CHIP R 1.0M J 1/10W	
R47			RK73GB2A104J	CHIP R 100K J 1/10W	
R48,49			RK73GB2A331J	CHIP R 330 J 1/10W	
R50			RK73GB2A101J	CHIP R 100 J 1/10W	
R51			RK73GB2A392J	CHIP R 3.9K J 1/10W	
R52			RK73GB2A163J	CHIP R 16K J 1/10W	
R53			RK73GB2A123J	CHIP R 12K J 1/10W	
R54			RK73GB2A333J	CHIP R 33K J 1/10W	
R55			RK73GB2A103J	CHIP R 10K J 1/10W	
R56			RK73GB2A123J	CHIP R 12K J 1/10W	
R57,58			RK73GB2A133J	CHIP R 13K J 1/10W	
R59			RK73GB2A472J	CHIP R 4.7K J 1/10W	
R60			RK73GB2A123J	CHIP R 12K J 1/10W	
R61			RK73GB2A183J	CHIP R 18K J 1/10W	
R62			RK73GB2A432J	CHIP R 4.3K J 1/10W	
R63			RK73GB2A133J	CHIP R 13K J 1/10W	
R64			RK73GB2A151J	CHIP R 150 J 1/10W	
R65			RK73GB2A104J	CHIP R 100K J 1/10W	
R66			RK73GB2A472J	CHIP R 4.7K J 1/10W	
R67			RK73GB2A222J	CHIP R 2.2K J 1/10W	
R68,69			RK73GB2A104J	CHIP R 100K J 1/10W	
R70			RK73GB2A102J	CHIP R 1.0K J 1/10W	
S1,2			S68-0863-05	PUSH SWITCH	
S3			S68-0862-05	PUSH SWITCH	
D2			DA204UF	DIODE	
D3			DAN202UF	DIODE	
IC1			91CW12AFG-5AR1	MICROCONTROLLER IC	
IC2			UPD63712GC	MOS-IC	
IC3			TC94A20F-010	MOS-IC	
IC4			BA5824FP-F	ANALOGUE IC	
IC5			NJM2880U133	ANALOGUE IC	
IC5			NJM2880U33	ANALOGUE IC	
IC6			S-1112B33MCG	ANALOGUE IC	
IC6			XC6219B332MR	ANALOGUE IC	
IC7			S-1112B25MCG	ANALOGUE IC	
IC7			XC6219B252MR	ANALOGUE IC	
IC8			TC7SH08FU	MOS-IC	
IC9			TAR5S33-F	ANALOGUE IC	
Q1			2SK3018F	FET	
Q3			UMD9N	TRANSISTOR	
Q4			2SK3018F	FET	
Q5			UMD9N	TRANSISTOR	
Q6			UMD12N	TRANSISTOR	
Q7			DTC124EUAF	DIGITAL TRANSISTOR	
Q8			2SB0970	TRANSISTOR	
Q9,10			DTC114YUAF	DIGITAL TRANSISTOR	
ELECTRIC UNIT (X34-3402-7x)					
D401			B30-1567-05	LED (RED)	

PARTS LIST

ELECTRIC UNIT (X34-3402-7x)

Ref. No.	Add	New	Parts No.	Description	Destination	Ref. No.	Add	New	Parts No.	Description	Destination
C1,2			CD04AT1HR47M	ELECTRO 0.47UF 50WV		C503			CK73GB1C104K	CHIP C 0.10UF K	
C3-6			C90-5684-05	ELECTRO 0.22UF 50WV		C504			CK73GB1H103K	CHIP C 0.010UF K	
C3-6		*	C90-6735-05	ELECTRO 0.22UF 50WV		C505			CD04AT1C4R7M	ELECTRO 4.7UF 16WV	
C51			C90-5683-05	ELECTRO 3300UF 16WV	E3E6	C506			CK73GB1A684K	CHIP C 0.68UF K	
C51		*	C90-6746-05	ELECTRO 3300UF 16WV	EE1E2	C507,508			CD04AT1A220M	ELECTRO 22UF 10WV	
C51		*	C90-6746-05	ELECTRO 3300UF 16WV	E7E8E9	C509			CC73GCH1H680J	CHIP C 68PF J	
C52,53			CK73GB1H102K	CHIP C 1000PF K		C510			CC73GCH1H101J	CHIP C 100PF J	
C54,55			CK73GB1H103K	CHIP C 0.010UF K		C512			CD04AT1C100M	ELECTRO 10UF 16WV	
C69			CK73GB1A474K	CHIP C 0.47UF K		C513,514			CK73GB1H103K	CHIP C 0.010UF K	
C71			CD04AS1C470M	ELECTRO 47UF 16WV		C515			CD04AT1H010M	ELECTRO 1UF 50WV	
C72			CK73GB1H104K	CHIP C 0.10UF K		C516			CC73GCH1H100D	CHIP C 10PF D	
C74-77			CK73GB1C104K	CHIP C 0.10UF K		C517,518			CK73FB1C105K	CHIP C 1.0UF K	
C78		*	CD04AT1E101M	ELECTRO 100UF 25WV		C519,520			CK73FB1C474K	CHIP C 0.47UF K	
C79			CD04AS1A220M	ELECTRO 22UF 10WV		C521,522			CC73GCH1H102J	CHIP C 1000PF J	
C80		*	CD04AT1E101M	ELECTRO 100UF 25WV		C524			CC73GCH1H180J	CHIP C 18PF J	
C81			CK73GB1H103K	CHIP C 0.010UF K		C525			CC73GCH1H150J	CHIP C 15PF J	
C82			CK73GB1E223K	CHIP C 0.022UF K		C527			CC73GCH1H102J	CHIP C 1000PF J	
C82			CK73GB1H223K	CHIP C 0.022UF K		C531			CK73FB1C105K	CHIP C 1.0UF K	
C96			CD04AS1HR47M	ELECTRO 0.47UF 50WV		C541			CC73GCH1H271J	CHIP C 270PF J	
C97			CD04AS1C470M	ELECTRO 47UF 16WV		C542			CC73GCH1H050C	CHIP C 5.0PF C	
C112,113			CC73GCH1H100D	CHIP C 10PF D	EE1E2	C543			CC73GCH1H080D	CHIP C 8.0PF D	
C112,113			CC73GCH1H100D	CHIP C 10PF D	E6E7E8	C544			CC73GCH1H150J	CHIP C 15PF J	
C112,113			CC73GCH1H100D	CHIP C 10PF D	E9	C545			CK73GB1H682K	CHIP C 6800PF K	
C116			CC73GCH1H331J	CHIP C 330PF J	EE1E2	C547			CD04AT1A220M	ELECTRO 22UF 10WV	
C116			CC73GCH1H331J	CHIP C 330PF J	E6E7E8	C548			CK73GB1E223K	CHIP C 0.022UF K	
C116			CC73GCH1H331J	CHIP C 330PF J	E9	C548			CK73GB1H223K	CHIP C 0.022UF K	
C117			CD04AS1H2R2M	ELECTRO 2.2UF 50WV	EE1E2	C549			CK73GB1H222K	CHIP C 2200PF K	
C117			CD04AS1H2R2M	ELECTRO 2.2UF 50WV	E6E7E8	C550			CK73GB1E333K	CHIP C 0.033UF K	
C117			CD04AS1H2R2M	ELECTRO 2.2UF 50WV	E9	C550			CK73GB1H333K	CHIP C 0.033UF K	
C118			CK73GB1H103K	CHIP C 0.010UF K	EE1E2	C551			CK73GB1H103K	CHIP C 0.010UF K	
C118			CK73GB1H103K	CHIP C 0.010UF K	E6E7E8	C553			CK73GB1C104K	CHIP C 0.10UF K	
C119			CD04AS1C100M	ELECTRO 10UF 16WV	E9	C554			CK73GB1A334K	CHIP C 0.33UF K	
C119			CD04AS1C100M	ELECTRO 10UF 16WV	EE1E2	C555			CK73GB1H103K	CHIP C 0.010UF K	
C119			CD04AS1C100M	ELECTRO 10UF 16WV	E6E7E8	C559			CK73GB1H332K	CHIP C 3300PF K	
C119			CD04AS1C100M	ELECTRO 10UF 16WV	E9	C561			CK73FB1H104K	CHIP C 0.10UF K	
C153			CK73GB0J105K	CHIP C 1.0UF K		C562			CD04AT1A100M	ELECTRO 10UF 10WV	
C201			CK73GB1H103K	CHIP C 0.010UF K		C563			CD04AT1HR47M	ELECTRO 0.47UF 50WV	
C255			CD04AS1A330M	ELECTRO 33UF 10WV	EE1E2	C564			CK73GB1A474K	CHIP C 0.47UF K	
C255			CD04AS1A330M	ELECTRO 33UF 10WV	E7E8E9	C565			CK73FB1C105K	CHIP C 1.0UF K	
C255			CD04AS1C100M	ELECTRO 10UF 16WV	E3E6	C568			CC73GCH1H271J	CHIP C 270PF J	
C256			CD04AS1H010M	ELECTRO 1UF 50WV		C579			CK73GB1H103K	CHIP C 0.010UF K	
C257			CD04AT1H010M	ELECTRO 1UF 50WV		C581			CC73GCH1H101J	CHIP C 100PF J	
C258			CD04AS1H010M	ELECTRO 1UF 50WV		C582			CK73GB1E223K	CHIP C 0.022UF K	
C301,302			CK73FB1C474K	CHIP C 0.47UF K	EE7	C582			CK73GB1H223K	CHIP C 0.022UF K	
C303			CD04AT1A470M	ELECTRO 47UF 10WV	EE7	C583			CK73GB1C683K	CHIP C 0.068UF K	
C331,332			CD04AT1C100M	ELECTRO 10UF 16WV		C583			CK73GB1H683K	CHIP C 0.068UF K	
C333,334			CC73GCH1H681J	CHIP C 680PF J		C584			CD04AT1H010M	ELECTRO 1UF 50WV	
C407			CC73GCH1H220J	CHIP C 22PF J		C585			CK73GB1H103K	CHIP C 0.010UF K	
C408			CC73GCH1H180J	CHIP C 18PF J		C586			CK73GB0J105K	CHIP C 1.0UF K	
C409			CD04AS0J101M	ELECTRO 100UF 6.3WV		C587			CK73GB1C104K	CHIP C 0.10UF K	
C410			CK73GB1H103K	CHIP C 0.010UF K		C588			CK73GB1A474K	CHIP C 0.47UF K	
C411			CK73GB1A224K	CHIP C 0.22UF K		C589			CK73GB1C104K	CHIP C 0.10UF K	
C420			CC73GCH1H102J	CHIP C 1000PF J		C590			CK73GB1H392K	CHIP C 3900PF K	
C422			CC73GCH1H101J	CHIP C 100PF J		C600			CD04AT1A101M	ELECTRO 100UF 10WV	
C502			CK73GB1H152K	CHIP C 1500PF K		C601			CK73GB1E223K	CHIP C 0.022UF K	

E : KDC-W4531 E1 : KDC-W4031 E2 : KDC-W409 E3 : KDC-W431GY E6 : KDC-WF431A
E7 : KDC-W4531Y E8 : KDC-W4031Y E9 : KDC-W409Y
(E : Europe K : North America M : Other Areas W : Without Europe)

△ Indicates safety critical components.

PARTS LIST

ELECTRIC UNIT (X34-3402-7x)

Ref. No.	A	N	Parts No.	Description	Desti- nation	Ref. No.	A	N	Parts No.	Description	Desti- nation
	d	e					d	e			
C601			CK73GB1H223K	CHIP C 0.022UF K		W401-410			E31-0001-00	JUMPER WIRE	
C602			CC73GCH1H151J	CHIP C 150PF J		W412-427			E31-0001-00	JUMPER WIRE	
C604			CC73GCH1H470J	CHIP C 47PF J		W801			E31-0001-00	JUMPER WIRE	
C605,606			CC73GCH1H010C	CHIP C 1.0PF C		W830			E31-0001-00	JUMPER WIRE	
C610			CC73GCH1H010C	CHIP C 1.0PF C							
C620			CK73GB1H103K	CHIP C 0.010UF K		CF51-53	*		L72-0805-05	CERAMIC FILTER (10.7MHZ)	
C623,624			CK73GB1H103K	CHIP C 0.010UF K		CF54	*		L72-0804-05	CERAMIC FILTER (450KHZ)	
C625,626			CC73GCH1H101J	CHIP C 100PF J		L3			L33-1978-05	CHOKE COIL (22UH)	
						L4	*		L33-2260-05	CHOKE COIL (52UH)	
						L51			L33-1988-05	CHOKE COIL ASSY (140UH)	
CN2		*	E41-2244-05	FLAT CABLE CONNECTOR		L61			L40-4795-91	SMALL FIXED INDUCTOR (4.7UH, J)	
CN3			E41-0941-05	PIN ASSY	EE1E2	L101			L40-4795-91	SMALL FIXED INDUCTOR (4.7UH, J)	EE1E2
CN3			E41-0941-05	PIN ASSY	E6E7E8	L101			L40-4795-91	SMALL FIXED INDUCTOR (4.7UH, J)	E6E7E8
CN3			E41-0941-05	PIN ASSY	E9	L101			L40-4795-91	SMALL FIXED INDUCTOR (4.7UH, J)	E9
J1			E58-0991-05	RECTANGULAR RECEPTACLE		L501			L40-6891-58	SMALL FIXED INDUCTOR (6.8UH)	
J2			E56-0855-05	CYLINDRICAL RECEPTACLE	EE7						
J4			E04-0326-05	RF COAXIAL CABLE RECEPTACLE		L502			L40-3301-58	SMALL FIXED INDUCTOR (33UH)	
J5		*	E58-0992-05	RECTANGULAR RECEPTACLE		L503			L40-1021-56	SMALL FIXED INDUCTOR (1UH)	
J6			E63-0898-05	PIN JACK		L504			L40-1011-58	SMALL FIXED INDUCTOR (100UH)	
P1			E23-0745-05	TERMINAL		L505	*		L40-3381-58	SMALL FIXED INDUCTOR (0.33UH)	
						L506	*		L31-0977-15	FM-RF COIL	
W251			E31-0001-00	JUMPER WIRE	E3E6	L507	*		L32-0941-15	FM OSCILLATING COIL	
W300-302			E31-0001-00	JUMPER WIRE	E3	L508	*		L30-0776-15	FM IFT	
W300-311			E31-0001-00	JUMPER WIRE	E1E2E6	L509	*		L30-0777-15	AM IFT	
W300-311			E31-0001-00	JUMPER WIRE	E8E9	L518	*		L31-0976-15	FM-RF COIL	
W300-324			E31-0001-00	JUMPER WIRE	EE7	L519	*		L40-4763-72	SMALL FIXED INDUCTOR (4.7NH)	
W304-311			E31-0001-00	JUMPER WIRE	E3						
W313-324			E31-0001-00	JUMPER WIRE	E1E2E3	L520	*		L40-3381-58	SMALL FIXED INDUCTOR (0.33UH)	
W313-324			E31-0001-00	JUMPER WIRE	E6E8E9	L521	*		L40-1073-72	SMALL FIXED INDUCTOR (10NH)	
W326-329			E31-0001-00	JUMPER WIRE	E3	L600	*		L92-0607-05	CHIP FERRITE	
W326-337			E31-0001-00	JUMPER WIRE	E1E2E6	L601,602	*		L92-0397-05	CHIP FERRITE	
						X1			L78-0879-05	RESONATOR (10.000MHZ)	
W326-337			E31-0001-00	JUMPER WIRE	E8E9	X2			L77-2793-05	CRYSTAL RESONATOR (32.768KHZ)	
W326-345			E31-0001-00	JUMPER WIRE	EE7	X3			L77-2002-05	CRYSTAL RESONATOR (4.332MHZ)	EE1E2
W331-337			E31-0001-00	JUMPER WIRE	E3	X3			L77-2002-05	CRYSTAL RESONATOR (4.332MHZ)	E6E7E8
W339-341			E31-0001-00	JUMPER WIRE	E1E2E3	X3			L77-2002-05	CRYSTAL RESONATOR (4.332MHZ)	E9
W339-341			E31-0001-00	JUMPER WIRE	E6E8E9	X301			L77-2077-05	CRYSTAL RESONATOR (10.250MHZ)	
W345			E31-0001-00	JUMPER WIRE	E1E2E8						
W345			E31-0001-00	JUMPER WIRE	E9	F	2D	*	N80-3010-48	PAN HEAD TAPTITE SCREW	
W345-347			E31-0001-00	JUMPER WIRE	E6	G	2D	*	N83-3005-48	PAN HEAD TAPTITE SCREW	
W346,347			E31-0001-00	JUMPER WIRE	E3	H	2D	*	N83-3020-48	PAN HEAD TAPTITE SCREW	
W347			E31-0001-00	JUMPER WIRE	E1E2E8	J	3D	*	N86-2606-48	BINDING HEAD TAPTITE SCREW	
W347			E31-0001-00	JUMPER WIRE	E9	R1,2			RK73GB2A101J	CHIP R 100 J 1/10W	
W347-366			E31-0001-00	JUMPER WIRE	EE7	R21			RD14BB2C152J	RD 1.5K J 1/6W	
W349-353			E31-0001-00	JUMPER WIRE	E1E2E3	R51			RK73FB2B683J	CHIP R 68K J 1/8W	
W349-353			E31-0001-00	JUMPER WIRE	E6E8E9	R52			RK73GB2A393J	CHIP R 39K J 1/10W	
W355-357			E31-0001-00	JUMPER WIRE	E1E2E3	R53			RK73GB2A104J	CHIP R 100K J 1/10W	
W355-357			E31-0001-00	JUMPER WIRE	E6E8E9	R54			RK73FB2B203J	CHIP R 20K J 1/8W	
W361-366			E31-0001-00	JUMPER WIRE	E1E2E3	R55,56			RK73GB2A103J	CHIP R 10K J 1/10W	
W361-366			E31-0001-00	JUMPER WIRE	E6E8E9	R57			RK73GB2A223J	CHIP R 22K J 1/10W	
W368-372			E31-0001-00	JUMPER WIRE	E3	R58			RD14DB2H332J	SMALL-RD 3.3K J 1/2W	
W368-399			E31-0001-00	JUMPER WIRE	E6	R59			RD14BB2C333J	RD 33K J 1/6W	
W369-376			E31-0001-00	JUMPER WIRE	EE1E2	R60			RK73GB2A103J	CHIP R 10K J 1/10W	
W369-376			E31-0001-00	JUMPER WIRE	E7E8E9	R61			RK73GB2A223J	CHIP R 22K J 1/10W	
W374-393			E31-0001-00	JUMPER WIRE	E3	R72,73			RD14BB2C472J	RD 4.7K J 1/6W	
W378-399			E31-0001-00	JUMPER WIRE	EE1E2	R75-78			RK73GB2A103J	CHIP R 10K J 1/10W	
W378-399			E31-0001-00	JUMPER WIRE	E7E8E9	R81			RD14BB2C103J	RD 10K J 1/6W	
W395-399			E31-0001-00	JUMPER WIRE	E3	R82			RK73GB2A223J	CHIP R 22K J 1/10W	

E : KDC-W4531 E1 : KDC-W4031 E2 : KDC-W409 E3 : KDC-W431GY E6 : KDC-WF431A
E7 : KDC-W4531Y E8 : KDC-W4031Y E9 : KDC-W409Y

△ Indicates safety critical components.

PARTS LIST

ELECTRIC UNIT (X34-3402-7x)

Ref. No.	Add	New	Parts No.	Description	Destination	Ref. No.	Add	New	Parts No.	Description	Destination
R83			RK73GB2A473J	CHIP R 47K J 1/10W		R272			RK73GB2A103J	CHIP R 10K J 1/10W	
R85			RK73GB2A1R0J	CHIP R 1.0 J 1/10W		R273			RK73GB2A474J	CHIP R 470K J 1/10W	
R86			RK73EB2E1R0J	CHIP R 1.0 J 1/4W		R301,302			RK73EB2E100J	CHIP R 10 J 1/4W	EE7
R87,88			RK73GB2A1R0J	CHIP R 1.0 J 1/10W		R303			RK73EB2E101J	CHIP R 100 J 1/4W	EE7
R90			RK73GB2A1R0J	CHIP R 1.0 J 1/10W		R304,305			RK73EB2E472J	CHIP R 4.7K J 1/4W	EE7
R96			RK73GH2A273D	CHIP R 27K D 1/10W		R306			RK73EB2E4R7J	CHIP R 4.7 J 1/4W	EE7
R97		*	RK73GH2A332D	CHIP R 3.3K D 1/10W		R307-309			RK73EB2E472J	CHIP R 4.7K J 1/4W	EE7
R98			RK73EB2E102J	CHIP R 1.0K J 1/4W		R310,311			RK73EB2E101J	CHIP R 100 J 1/4W	EE7
R99			RK73GB2A104J	CHIP R 100K J 1/10W		R312			RD14BB2C104J	RD 100K J 1/6W	EE7
R100			RK73GB2A272J	CHIP R 2.7K J 1/10W		R313			RK73GB2A104J	CHIP R 100K J 1/10W	EE7
R112-114			RK73GB2A222J	CHIP R 2.2K J 1/10W	EE1E2	R331,332			RK73GB2A271J	CHIP R 270 J 1/10W	
R112-114			RK73GB2A222J	CHIP R 2.2K J 1/10W	E6E7E8	R335,336			RK73GB2A303J	CHIP R 30K J 1/10W	
R112-114			RK73GB2A222J	CHIP R 2.2K J 1/10W	E9	R338,339			RD14BB2C101J	RD 100 J 1/6W	
R130,131			RK73EB2E4R7J	CHIP R 4.7 J 1/4W		R351,352			RK73GB2A222J	CHIP R 2.2K J 1/10W	
R133			RK73EB2E4R7J	CHIP R 4.7 J 1/4W		R353			RK73GB2A102J	CHIP R 1.0K J 1/10W	
R135-140			RK73EB2E4R7J	CHIP R 4.7 J 1/4W		R355,356			RK73GB2A102J	CHIP R 1.0K J 1/10W	
R141			RK73EB2E2R2J	CHIP R 2.2 J 1/4W		R358			RK73GB2A222J	CHIP R 2.2K J 1/10W	
R152			RK73EB2E100J	CHIP R 10 J 1/4W		R359			RK73GB2A101J	CHIP R 100 J 1/10W	
R153			RK73EB2E471J	CHIP R 470 J 1/4W		R360			RK73GB2A222J	CHIP R 2.2K J 1/10W	
R156,157			RK73EB2E102J	CHIP R 1.0K J 1/4W		R363			RD14BB2C472J	RD 4.7K J 1/6W	
R158			RK73EB2E101J	CHIP R 100 J 1/4W		R365			RK73GB2A472J	CHIP R 4.7K J 1/10W	
R159			RK73EB2E102J	CHIP R 1.0K J 1/4W		R366			RK73EB2E472J	CHIP R 4.7K J 1/4W	
R160,161			RK73EB2E471J	CHIP R 470 J 1/4W		R367			RK73GB2A104J	CHIP R 100K J 1/10W	
R162			RK73EB2E102J	CHIP R 1.0K J 1/4W	EE1E2	R368,369			RK73GB2A471J	CHIP R 470 J 1/10W	
R162			RK73EB2E102J	CHIP R 1.0K J 1/4W	E6E7E8	R370,371			RK73GB2A472J	CHIP R 4.7K J 1/10W	
R162			RK73EB2E102J	CHIP R 1.0K J 1/4W	E9	R411			RK73GB2A223J	CHIP R 22K J 1/10W	E3
R163			RK73EB2E471J	CHIP R 470 J 1/4W		R412			RK73GB2A223J	CHIP R 22K J 1/10W	E6
R164			RK73EB2E102J	CHIP R 1.0K J 1/4W		R412,413			RK73GB2A223J	CHIP R 22K J 1/10W	EE1E2
R172			RD14BB2C102J	RD 1.0K J 1/6W	EE1E2	R412,413			RK73GB2A223J	CHIP R 22K J 1/10W	E7E8E9
R172			RD14BB2C102J	RD 1.0K J 1/6W	E6E7E8	R414			RK73GB2A223J	CHIP R 22K J 1/10W	E3E6
R172			RD14BB2C102J	RD 1.0K J 1/6W	E9	R415			RK73GB2A223J	CHIP R 22K J 1/10W	EE7
R178			RK73EB2E471J	CHIP R 470 J 1/4W		R416-418			RK73GB2A223J	CHIP R 22K J 1/10W	E1E2E3
R180,181			RK73GB2A471J	CHIP R 470 J 1/10W		R416-418			RK73GB2A223J	CHIP R 22K J 1/10W	E6E8E9
R182			RK73GB2A222J	CHIP R 2.2K J 1/10W		R417,418			RK73GB2A223J	CHIP R 22K J 1/10W	EE7
R190			RK73GB2A104J	CHIP R 100K J 1/10W		R431			RK73GB2A223J	CHIP R 22K J 1/10W	EE1E2
R191			RK73GB2A225J	CHIP R 2.2M J 1/10W		R431			RK73GB2A223J	CHIP R 22K J 1/10W	E6E8E9
R193,194			RK73GB2A474J	CHIP R 470K J 1/10W		R431			RK73GB2A223J	CHIP R 22K J 1/10W	E9
R199			RK73GB2A241J	CHIP R 240 J 1/10W		R432			RK73GB2A472J	CHIP R 4.7K J 1/10W	
R200			RK73GB2A102J	CHIP R 1.0K J 1/10W		R433			RK73GB2A222J	CHIP R 2.2K J 1/10W	
R251			RK73GB2A154J	CHIP R 150K J 1/10W	E3E6	R435,436			RK73GB2A103J	CHIP R 10K J 1/10W	
R251			RK73GB2A333J	CHIP R 33K J 1/10W	EE1E2	R437,438			RK73GB2A102J	CHIP R 1.0K J 1/10W	
R251			RK73GB2A333J	CHIP R 33K J 1/10W	E7E8E9	R439			RK73GB2A222J	CHIP R 2.2K J 1/10W	
R252			RK73GB2A473J	CHIP R 47K J 1/10W		R440,441			RK73GB2A473J	CHIP R 47K J 1/10W	
R253			RK73GB2A432J	CHIP R 4.3K J 1/10W		R453			RK73GB2A473J	CHIP R 47K J 1/10W	
R254			RK73GB2A100J	CHIP R 10 J 1/10W		R454			RK73GB2A472J	CHIP R 4.7K J 1/10W	
R255			RK73GB2A221J	CHIP R 220 J 1/10W	EE1E2	R456			RK73GB2A104J	CHIP R 100K J 1/10W	
R255			RK73GB2A221J	CHIP R 220 J 1/10W	E7E8E9	R457			RK73GB2A103J	CHIP R 10K J 1/10W	
R255			RK73GB2A331J	CHIP R 330 J 1/10W	E3E6	R470			RK73GB2A222J	CHIP R 2.2K J 1/10W	EE1E2
R256			RK73GB2A154J	CHIP R 150K J 1/10W	E3E6	R470			RK73GB2A222J	CHIP R 2.2K J 1/10W	E6E7E8
R256			RK73GB2A223J	CHIP R 22K J 1/10W	EE1E2	R470			RK73GB2A222J	CHIP R 2.2K J 1/10W	E9
R256			RK73GB2A223J	CHIP R 22K J 1/10W	E7E8E9	R471			RK73GB2A103J	CHIP R 10K J 1/10W	E3
R257			RK73GB2A123J	CHIP R 12K J 1/10W	E3E6	R480			RK73GB2A104J	CHIP R 100K J 1/10W	EE7
R257			RK73GB2A303J	CHIP R 30K J 1/10W	EE1E2	R501			RK73GB2A682J	CHIP R 6.8K J 1/10W	
R257			RK73GB2A303J	CHIP R 30K J 1/10W	E7E8E9	R502,503			RK73GB2A222J	CHIP R 2.2K J 1/10W	
R271			RK73GB2A101J	CHIP R 100 J 1/10W		R504			RK73GB2A4R7J	CHIP R 4.7 J 1/10W	

E : KDC-W4531 E1 : KDC-W4031 E2 : KDC-W409 E3 : KDC-W431GY E6 : KDC-WF431A
E7 : KDC-W4531Y E8 : KDC-W4031Y E9 : KDC-W409Y
(E : Europe K : North America M : Other Areas W : Without Europe)

△ Indicates safety critical components.

PARTS LIST

ELECTRIC UNIT (X34-3402-7x)

Ref. No.	A	N	Parts No.	Description	Desti- nation	Ref. No.	A	N	Parts No.	Description	Desti- nation
	d	e					d	e			
R505			RK73GB2A102J	CHIP R 1.0K J 1/10W		W87			R92-2053-05	CHIP R 0 OHM J 1/8W	
R506			RK73GB2A105J	CHIP R 1.0M J 1/10W		W88,89			R92-1252-05	CHIP R 0 OHM J 1/16W	
R507			RK73GB2A102J	CHIP R 1.0K J 1/10W		W90,91			R92-2053-05	CHIP R 0 OHM J 1/8W	
R520			RK73GB2A221J	CHIP R 220 J 1/10W		W92			R92-1252-05	CHIP R 0 OHM J 1/16W	
R521			RK73GB2A152J	CHIP R 1.5K J 1/10W		W93			R92-2053-05	CHIP R 0 OHM J 1/8W	E3
R522			RK73GB2A223J	CHIP R 22K J 1/10W		W93,94			R92-2053-05	CHIP R 0 OHM J 1/8W	EE1E2
R543			RK73GB2A562J	CHIP R 5.6K J 1/10W		W93,94			R92-2053-05	CHIP R 0 OHM J 1/8W	E6E7E8
R544			RD14BB2C222J	RD 2.2K J 1/6W		W93,94			R92-2053-05	CHIP R 0 OHM J 1/8W	E9
R545			RK73GB2A333J	CHIP R 33K J 1/10W		W96-98			R92-1252-05	CHIP R 0 OHM J 1/16W	
R546			RK73GB2A432J	CHIP R 4.3K J 1/10W		W99			R92-2053-05	CHIP R 0 OHM J 1/8W	
R561			RK73GB2A472J	CHIP R 4.7K J 1/10W		W102			R92-2053-05	CHIP R 0 OHM J 1/8W	
R562			RK73GB2A106J	CHIP R 10M J 1/10W		W252			R92-1252-05	CHIP R 0 OHM J 1/16W	EE1E2
R565			RK73GB2A394J	CHIP R 390K J 1/10W		W252			R92-1252-05	CHIP R 0 OHM J 1/16W	E7E8E9
R566,567			RK73GB2A102J	CHIP R 1.0K J 1/10W		W506			R92-2053-05	CHIP R 0 OHM J 1/8W	
R589			RK73GB2A473J	CHIP R 47K J 1/10W		W604,605			R92-1252-05	CHIP R 0 OHM J 1/16W	
R590			RK73GB2A103J	CHIP R 10K J 1/10W		W611			R92-1252-05	CHIP R 0 OHM J 1/16W	
R591			RK73GB2A513J	CHIP R 51K J 1/10W		W802			R92-1252-05	CHIP R 0 OHM J 1/16W	
R592			RK73GB2A223J	CHIP R 22K J 1/10W		W804-807			R92-1252-05	CHIP R 0 OHM J 1/16W	
R594			RK73EB2E100J	CHIP R 10 J 1/4W		W808			R92-2053-05	CHIP R 0 OHM J 1/8W	
R595-597			RD14BB2C100J	RD 10 J 1/6W		W810			R92-1252-05	CHIP R 0 OHM J 1/16W	
R599			RK73GB2A220J	CHIP R 22 J 1/10W		W812			R92-2053-05	CHIP R 0 OHM J 1/8W	
R600			RD14BB2C2R2J	RD 2.2 J 1/6W		W814			R92-2053-05	CHIP R 0 OHM J 1/8W	
R601			RD14BB2C1R0J	RD 1.0 J 1/6W		W820			R92-2053-05	CHIP R 0 OHM J 1/8W	
R602			RK73GB2A122J	CHIP R 1.2K J 1/10W		W823			R92-1252-05	CHIP R 0 OHM J 1/16W	
R603			RK73GB2A560J	CHIP R 56 J 1/10W		W826			R92-2053-05	CHIP R 0 OHM J 1/8W	
R604,605			RK73GB2A100J	CHIP R 10 J 1/10W		D3			IMSA-6801-E	SURGE ABSORBER	
W51			R92-1252-05	CHIP R 0 OHM J 1/16W		D52			MAZ4068N-M	ZENER DIODE	
W52			R92-2053-05	CHIP R 0 OHM J 1/8W		D53			UDZS6.8B	ZENER DIODE	
W53			R92-1252-05	CHIP R 0 OHM J 1/16W		D53	*		02DZ6.8F-Y	ZENER DIODE	
W57			R92-2053-05	CHIP R 0 OHM J 1/8W	EE1E2	D54			MAZ4068N-M	ZENER DIODE	
W57			R92-2053-05	CHIP R 0 OHM J 1/8W	E6E7E8	D55			1SS355	DIODE	
W57			R92-2053-05	CHIP R 0 OHM J 1/8W	E9	D57			S2V60*A	DIODE	
W58-60			R92-1252-05	CHIP R 0 OHM J 1/16W		D71			MAZ4082N-L	ZENER DIODE	
W61-63			R92-2053-05	CHIP R 0 OHM J 1/8W		D72			D1F60-5063	DIODE	
W64			R92-1252-05	CHIP R 0 OHM J 1/16W		D72			1SR154-400	DIODE	
W65,66			R92-2053-05	CHIP R 0 OHM J 1/8W		D73			AM01ZNF	DIODE	
W67-71			R92-1252-05	CHIP R 0 OHM J 1/16W	EE1E2	D73	*		10EDA20	DIODE	
W67-71			R92-1252-05	CHIP R 0 OHM J 1/16W	E6E7E8	D74,75			D1F60-5063	DIODE	
W67-71			R92-1252-05	CHIP R 0 OHM J 1/16W	E9	D74,75			1SR154-400	DIODE	
W68			R92-1252-05	CHIP R 0 OHM J 1/16W	E3	D76			DAN202U	DIODE	
W71			R92-1252-05	CHIP R 0 OHM J 1/16W	E3	D76	*		KDS121-P	DIODE	
W72			R92-2053-05	CHIP R 0 OHM J 1/8W		D76	*		MC2848	DIODE	
W73			R92-1252-05	CHIP R 0 OHM J 1/16W		D77			AM01ZNF	DIODE	
W75			R92-2053-05	CHIP R 0 OHM J 1/8W		D77	*		10EDA20	DIODE	
W76			R92-1252-05	CHIP R 0 OHM J 1/16W		D81			UDZS4.7B	ZENER DIODE	
W78			R92-2053-05	CHIP R 0 OHM J 1/8W		D81			02DZ4.7F-Y	ZENER DIODE	
W79,80			R92-1252-05	CHIP R 0 OHM J 1/16W		D162			MAZ4062-L	ZENER DIODE	EE1E2
W81,82			R92-2053-05	CHIP R 0 OHM J 1/8W		D162			MAZ4062-L	ZENER DIODE	E6E7E8
W83			R92-1252-05	CHIP R 0 OHM J 1/16W		D162			MAZ4062-L	ZENER DIODE	E9
W85			R92-2053-05	CHIP R 0 OHM J 1/8W	EE1E2	D203			1SS133	DIODE	
W85			R92-2053-05	CHIP R 0 OHM J 1/8W	E6E7E8	D251-253			D1F60-5063	DIODE	EE1E2
W85			R92-2053-05	CHIP R 0 OHM J 1/8W	E9	D251-253			D1F60-5063	DIODE	E7E8E9
W86			R92-1252-05	CHIP R 0 OHM J 1/16W	EE1E2	D251-253			1SR154-400	DIODE	EE1E2
W86			R92-1252-05	CHIP R 0 OHM J 1/16W	E6E7E8	D251-253			1SR154-400	DIODE	E7E8E9
W86			R92-1252-05	CHIP R 0 OHM J 1/16W	E9	D254			AM01ZNF	DIODE	EE1E2

E : KDC-W4531 E1 : KDC-W4031 E2 : KDC-W409 E3 : KDC-W431GY E6 : KDC-WF431A
E7 : KDC-W4531Y E8 : KDC-W4031Y E9 : KDC-W409Y

△ Indicates safety critical components.

PARTS LIST

ELECTRIC UNIT (X34-3402-7x)

Ref. No.	Add	New	Parts No.	Description	Destination
D254			AM01ZNF	DIODE	E7E8E9
D254		*	10EDA20	DIODE	EE1E2
D254		*	10EDA20	DIODE	E7E8E9
D255-258			D1F60-5063	DIODE	EE1E2
D255-258			D1F60-5063	DIODE	E7E8E9
D255-258			1SR154-400	DIODE	EE1E2
D255-258			1SR154-400	DIODE	E7E8E9
D259			1SS133	DIODE	E3E6
D259,260			1SS133	DIODE	EE1E2
D259,260			1SS133	DIODE	E7E8E9
D261			1SS355	DIODE	
D301-304			MAZ4062-L	ZENER DIODE	EE7
D305,306			MAZ4068N-M	ZENER DIODE	EE7
D402,403			DAN202U	DIODE	
D402,403		*	KDS121-P	DIODE	
D402,403		*	MC2848	DIODE	
D501			RN739F	DIODE	
D502,503		*	KP2311ETR-G	DIODE	
D504		*	KV1430STL-G	VARIABLE CAPACITANCE DIODE	
D506		*	HVC383B-E	VARIABLE CAPACITANCE DIODE	
IC1		*	784225GC256A	MICROCONTROLLER IC	
IC3		*	BD4912-V4	ANALOGUE IC	
IC4			E-TDA7560A	ANALOGUE IC	EE1E2
IC4			E-TDA7560A	ANALOGUE IC	E7E8E9
IC4		*	TB2904HQ	ANALOGUE IC	E3E6
IC6			TC7W02FU-F	MOS-IC	
IC7			E-TDA7479AD	ANALOGUE IC	EE1E2
IC7			E-TDA7479AD	ANALOGUE IC	E6E7E8
IC7			E-TDA7479AD	ANALOGUE IC	E9
IC8		*	S-80836CNNB-G	MOS-IC	
IC10		*	E-TDA7516	ANALOGUE IC	
IC11		*	BR24L04FV-W	ROM IC	
IC15		*	BA00CCWT	ANALOGUE IC	
Q51-53			2SC4081	TRANSISTOR	
Q71			UMC2N	TRANSISTOR	
Q72			2SB1565(E,F)	TRANSISTOR	
Q73			2SD1858	TRANSISTOR	
Q74			UMC2N	TRANSISTOR	
Q151			DTA114YUA	DIGITAL TRANSISTOR	
Q151		*	KRA307-P	DIGITAL TRANSISTOR	
Q151			RT1P144M	TRANSISTOR	
Q155			2SC4081	TRANSISTOR	
Q252		*	KTA2014P(Y,GR)	TRANSISTOR	
Q252			2SA1576A	TRANSISTOR	
Q252		*	2SA1603A	TRANSISTOR	
Q330			DTA124EUA	DIGITAL TRANSISTOR	
Q330			KRA303-P	DIGITAL TRANSISTOR	
Q330			RT1P241M	TRANSISTOR	
Q351,352			DTC143TUA	DIGITAL TRANSISTOR	
Q351,352			KRC410-P	DIGITAL TRANSISTOR	
Q351,352			RT1N430M	TRANSISTOR	
Q501		*	HN3G01J(BL)-F	TRANSISTOR	
TH1			PRF21BE471QB2	POSITIVE RESISTOR	

Ref. No.	Add	New	Parts No.	Description	Destination
MECHANISM UNIT (X92-4850-00)					
2	1B		A10-4827-32	CHASSIS	
5	1B		D10-4576-83	ARM ASSY	
8	2A		D10-4579-23	LEVER ASSY	
10	2A		D10-4581-13	ARM	
11	2A		D10-4582-13	ARM	
12	3A		D10-4583-03	ARM	
13	3A		D10-4584-03	ARM	
14	3B		D10-4585-03	ARM	
15	2A		D10-4586-13	SLIDER	
16	3B		D10-4587-52	SLIDER	
17	2B		D10-4588-13	SLIDER	
18	2B		D10-4595-04	ARM	
19	2B		D10-4596-24	ARM	
22	2A		D13-2151-04	GEAR	
23	2B		D13-2152-04	GEAR	
24	3B		D13-2153-04	GEAR	
25	3B		D13-2154-04	GEAR	
26	3B		D13-2155-04	WORM	
27	2B		D13-2156-14	GEAR	
28	3B		D13-2157-04	GEAR	
29	2B		D13-2158-04	GEAR	
30	2B		D13-2168-04	GEAR	
31	3B		D13-2171-04	GEAR	
32	1B		D13-2172-13	RACK (GEAR)	
33	2A		D14-0759-04	ROLLER	
35	2B		D21-2382-04	SHAFT	
36	1A		D23-0954-04	RETAINER	
37	1B		D39-0246-05	DAMPER	
38	2B		G01-3072-04	EXTENSION SPRING	
39	2A		G01-3073-04	TORSION COIL SPRING	
40	2A		G01-3074-04	EXTENSION SPRING	
41	1B		G01-3075-14	EXTENSION SPRING	
42	2A		G01-3076-04	EXTENSION SPRING	
43	1B		G01-3077-14	EXTENSION SPRING	
44	2B		G02-1399-04	FLAT SPRING	
45	2B		G02-1408-04	FLAT SPRING	
51	1A		J21-9676-32	MOUNTING HARDWARE	
52	3B		J21-9677-22	MOUNTING HARDWARE	
53	1B		J21-9678-13	MOUNTING HARDWARE	
55	1A		J90-1001-11	GUIDE	
56	1B		J90-1023-03	GUIDE	
DFPC1	3A		J84-0141-05	FLEXIBLE PRINTED WIRING BOARD	
A	2B		N09-4460-05	TAPTITE SCREW (OVAL P TAPTIT)	
B	1B		N09-4472-15	MACHINE SCREW (M1.7X8.0)	
C	2B		N09-6004-05	MACHINE SCREW (M1.7X2.5 IB-L)	
E	2B		N09-6007-05	MACHINE SCREW (PAN M2X2)	
F	1A		N09-6051-05	TAPTITE SCREW (BIND P 2X5)	
G	2A		N19-2163-04	FLAT WASHER	
H	1B		N39-2020-46	PAN HEAD MACHINE SCREW	
J	1B		N09-6108-05	MACHINE SCREW (M2*3.5)	
K	3B		N09-6155-05	SEMS (TAPTITE SCREW) (PT2X6)	

E : KDC-W4531 E1 : KDC-W4031 E2 : KDC-W409 E3 : KDC-W431GY E6 : KDC-WF431A
E7 : KDC-W4531Y E8 : KDC-W4031Y E9 : KDC-W409Y
(E : Europe K : North America M : Other Areas W : Without Europe)

△ Indicates safety critical components.

PARTS LIST

MECHANISM UNIT (X92-4850-00)

Ref. No.	A d d	N e w	Parts No.	Description	Desti- nation	Ref. No.	A d d	N e w	Parts No.	Description	Desti- nation
DM1	3B		T42-1066-04	DC MOTOR (SPINDLE)							
DM2	2B		T42-1067-04	DC MOTOR (LOADING)							
DPU1	2B		X93-2010-00	OPTICAL PICKUP ASSY							

CAPACITORS

CC 45 TH 1H 220 J
1 2 3 4 5 6

- 1 = Type ... ceramic, electrolytic, etc. 4 = Voltage rating
2 = Shape ... round, square, etc. 5 = Value
3 = Temp. coefficient 6 = Tolerance

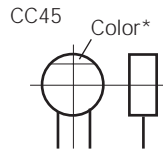

• Capacitor value

- 010 = 1pF
100 = 10pF
101 = 100pF
102 = 1000pF = 0.001μF
103 = 0.01μF

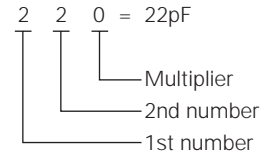

• Temperature coefficient

1st Word	C	L	P	R	S	T	U
Color*	Black	Red	Orange	Yellow	Green	Blue	Violet
ppm/°C	0	-80	-150	-220	-330	-470	-750

2nd Word	G	H	J	K	L
ppm/°C	±30	±60	±120	±250	±500

Example : CC45TH = -470±60ppm/°C

• Tolerance (More than 10pF)

Code	C	D	G	J	K	M	X	Z	P	No code
(%)	±0.25	±0.5	±2	±5	±10	±20	+40 -20	+80 -20	+100 -0	More than 10μF : -10~+50 Less than 4.7μF : -10~+75

(Less than 10pF)

Code	B	C	D	F	G
(pF)	±0.1	±0.25	±0.5	±1	±2

• Voltage rating

2nd word \ 1st word	A	B	C	D	E	F	G	H	J	K	V
0	1.0	1.25	1.6	2.0	2.5	3.15	4.0	5.0	6.3	8.0	-
1	10	12.5	16	20	25	31.5	40	50	63	80	35
2	100	125	160	200	250	315	400	500	630	800	-
3	1000	1250	1600	2000	2500	2150	4000	5000	6300	8000	-

CHIP CAPACITORS

(EX) CC 73 F SL 1H 000 J
1 2 3 4 5 6 7
(Chip) (CH, RH, UJ, SL)

(EX) CK 73 F F 1H 000 Z
1 2 3 4 5 6 7
(Chip) (B, F)

- Refer to the table above.
1 = Type
2 = Shape
3 = Dimension
4 = Temp. coefficient
5 = Voltage rating
6 = Value
7 = Tolerance

• Dimension

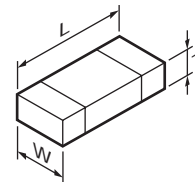

Chip capacitor

Code	L	W	T
Empty	5.6±0.5	5.0±0.5	Less than 2.0
A	4.5±0.5	3.2±0.4	Less than 2.0
B	4.5±0.5	2.0±0.3	Less than 2.0
C	4.5±0.5	1.25±0.2	Less than 1.25
D	3.2±0.4	2.5±0.3	Less than 1.5
E	3.2±0.2	1.6±0.2	Less than 1.25
F	2.0±0.3	1.25±0.2	Less than 1.25
G	1.6±0.2	0.8±0.2	Less than 1.0
H	1.0±0.05	0.5±0.05	0.5±0.05

Chip resistor

Code	L	W	T
E	3.2±0.2	1.6±0.2	1.0
F	2.0±0.3	1.25±0.2	1.0
G	1.6±0.2	0.8±0.2	0.5±0.1
H	1.0±0.05	0.5±0.05	0.35±0.05

RESISTORS

• Chip resistor (Carbon)

(EX) RD 73 E B 2B 000 J
1 2 3 4 5 6 7
(Chip) (B, F)

• Carbon resistor (Normal type)

(EX) RD 14 B B 2C 000 J
1 2 3 4 5 6 7
(Chip) (B, F)

- 1 = Type ... ceramic, electrolytic, etc. 5 = Voltage rating
2 = Shape ... round, square, etc. 6 = Value
3 = Dimension 7 = Tolerance
4 = Temp. coefficient

• Rating wattage

Code	Wattage	Code	Wattage	Code	Wattage
1J	1/16W	2C	1/6W	3A	1W
2A	1/10W	2E	1/4W	3D	2W
2B	1/8W	2H	1/2W		

SPECIFICATIONS

FM

Frequency Range (Frequency Step)
..... 87.5MHz~108.0MHz (50kHz)
Usable Sensitivity (S/N : 26dB) 0.7 μ V/75 Ω
Quieting Sensitivity (S/N : 46dB) 1.6 μ V/75 Ω
Frequency Response (\pm 3.0dB) 30Hz~15kHz
S/N 65dB (MONO)
Selectivity (DIN) \geq 80dB (\pm 400kHz)
Stereo Separation 35dB (1kHz)

MW (AM)

Frequency Range (Frequency Step)
..... 531kHz~1611kHz (9kHz)
Usable Sensitivity (S/N : 20dB) 25 μ V

LW

Frequency Range 153kHz~281kHz
Usable Sensitivity (S/N : 20dB) 45 μ V

CD

Laser Diode GaAIs
Digital Filter (D/A) 8 Times Over Sampling
D/A Converter 1 Bit
Spindle Speed 1000rpm~400rpm (CLV. 2 times)
Wow & Flutter Below Mesurable Limit
Frequency Response 10Hz~20kHz (\pm 1dB)
Total Harmonic Distortion 0.01% (1kHz)
S/N Ratio 105dB (1kHz)
Dynamic Range 93dB
Channel Separation 85dB
MP3 Decode Compliant with MPEG-1/2 Audio Layer-3
WMA Decode Compliant with WINDOWS MEDIA AUDIO

Preout Level / Load

KDC-W4031/W4031Y/W409/W409Y/W431GY/WF431A
..... 2000mV/10k Ω (CD)
KDC-W4531/W4531Y 2000mV/10k Ω (CD/CD-CH)
Preout Impedance \leq 600 Ω

AMPLIFIER

Maximum Power
KDC-W4031/W4031Y/W409/W409Y/W4531/W4531Y
..... 50W x 4
KDC-W431GY/WF431A 45W x 4
Power (DIN45324, +B=14.4V)
KDC-W4031/W4031Y/W409/W409Y/W4531/W4531Y
..... 30W x 4
KDC-W431GY/WF431A 28W x 4

STONE

Bass 100Hz \pm 10dB
Middle 1kHz \pm 10dB
Treble 10kHz \pm 10dB

GENERAL

Operating Voltage (11V~16V allowable) 14.4V
Current Consumption 10A
Installation Size (Width) 182mm
(Height) 53mm
(Depth) 155mm
Weight 1.40kg (3.1 lbs)

KENWOOD follows a policy of continuous advancements in development. For this reason specifications may be changed without notice.

KENWOOD CORPORATION

2967-3, Ishikawa-machi, Hachioji-shi, Tokyo, 192-8525 Japan

KENWOOD USA CORPORATION
P.O. Box 22745, 2201 East Dominguez Street, Long Beach, CA 90801-5745, U.S.A.

KENWOOD ELECTRONICS CANADA INC.
6070 Kestrel Road, Mississauga, Ontario, Canada L5T 1S8

KENWOOD ELECTRONICS LATIN AMERICA S.A.
P.O. Box 55-2791, Paitilla Plaza Credicorp Bank Panama Piso #9,
Oficina #901 Calle 50, Panama, Rep. De Panama

KENWOOD ELECTRONICS BRASIL LTDA.
Alameda Ministro Rocha Azevedo No. 456 Edifício Jaú,
10° Andar Cerqueira César, Cep 01410-001 São Paulo, SP, Brasil

KENWOOD ELECTRONICS UK LTD.
Kenwood House, Dwight Road, Watford, Herts, WD18 9EB, United Kingdom

KENWOOD ELECTRONICS DEUTSCHLAND GMBH
Rembrücker Str. 15, 63150 Heusenstamm, Germany

KENWOOD ELECTRONICS FRANCE S.A.
13, Boulevard Ney, 75018 Paris, France

KENWOOD ELECTRONICS BELGIUM N.V.
Leuvensesteenweg 248J, B-1800 Vilvoorde, Belgium

KENWOOD ELECTRONICS ITALIA S.p.A.
Via G. Sirtori 7/9, 20129 Milano, Italy

KENWOOD IBÉRICA S.A.
Bolivia, 239-08020 Barcelona, Spain

KENWOOD ELECTRONICS AUSTRALIA PTY. LTD.
(A.C.N. 001 499 074)
16 Giffnock Avenue, Centrecourt Estate, North Ryde, N.S.W. 2113, Australia

KENWOOD ELECTRONICS (HONG KONG) LTD.
Unit No. 3712-3724, Tower 1, Metroplaza, No. 223 Hing Fong Road, Kwai Fong, N.T., Hong Kong

KENWOOD ELECTRONICS GULF FZE
P.O. Box 61318, Jebel Ali, Dubai, U.A.E.

KENWOOD ELECTRONICS (THAILAND) CO., LTD.
2nd Floor, 956 Udom Vidhya Building, Rama IV Road, Silom, Bangrak, Bangkok 10500, Thailand

KENWOOD ELECTRONICS SINGAPORE PTE LTD.
1 Ang Mo Kio Street 63, Singapore 569110

KENWOOD ELECTRONICS MALAYSIA SDN BHD
#4.01 Level 4, Wisma Academy Lot 4A, Jalan 19/1,
46300 Petaling Jaya, Selangor, Malaysia

